

MTL Surge Technologies

Surge protection for electrical power installations

Synopsis

This publication discusses the affects of surges and lightning induced overvoltages on ac power systems. The note will introduce the source of many common transients and surges and suggest the application of surge protection devices in this area. Finally, typical examples are shown for common installations.

Application Note TAN 1009

Application Notes from MTL Surge Technologies

MTL Surge Technologies publish an increasing number of Application Notes providing easily understood information on various aspects of lightning and surge protection. At the date of publication of this Application Note, the list included:-

- TAN1001** Lightning surge protection for electronic equipment – *a practical guide*
A relatively brief and easy to understand introduction to the subject – an excellent starting point.
- TAN1002** Lightning and surge protection – *basic principles*
A more detailed account of the mechanism of lightning strikes and the measures needed to achieve an adequate level of protection.
- TAN1003** Earthing guide for surge protection
A detailed analysis of the subject of earthing for surge suppression purposes, this is both an easily understood exposition and a valuable reference document.
- TAN1004** Surge protection for intrinsically safe systems
A description of the best methods of combining surge protection and intrinsically safe systems.
- TAN1005** Surge protection for Zone 0 locations
A detailed analysis of this particular aspect of surge suppression in hazardous areas; complements TAN1004.
- TAN1006** Surge protection for weighing systems
Discusses, in some detail, the application of surge suppression to load-cell weighing systems.
- TAN1007** Surge protection for Local Area Networks
Discusses ways in which Local Area Networks can be damaged by lightning induced transients and how they can be protected economically.
- TAN1009** Surge protection for electrical power installations
Discusses aspects of how to protect and install mains devices, with information on earthing and mains systems. A guide to simple maintenance techniques for surge protection devices is included.

About MTL Surge Technologies

MTL Surge Technologies, the surge protection division of the MTL Instruments Group Plc, designs and manufactures a vast range of protection solutions for all your system surge protection requirements. Comprising of two independent but closely linked companies, Telematic and Atlantic Scientific Corporation, MTL Surge Technologies has a combined experience of nearly 50 years within the surge protection industry. MTL Surge Technologies supplies a wide range of Telematic and Atlantic Scientific surge protection devices offering solutions for all AC power, data and signal, telecom, network and wireless and HF systems.

The MTL Instruments Group has a strong and well respected presence within the Industrial Process market. This, combined with Telematic's close association with the Water Industry and Atlantic Scientific's presence in the Networks and Wireless Infrastructure market, means that MTL Surge Technologies is well placed to support a wide range of industries around the world.

CONTENTS

PAGE

CONTENTS	PAGE
1 INTRODUCTION	1
2 HOW SURGES ARISE	1
2.1 Expected Surge Levels	1
2.2 Location Categories - Zonal system	1
2.3 IEEE C62.41	1
2.4 Summary	2
3 HOW DO I PROTECT MY INSTALLATION?	2
3.1 Operation of a surge protection device	2
3.2 Series or 'in-line' devices	3
3.3 Parallel or 'shunt' devices	3
3.4 Replaceable modules	3
3.5 RFI filtering	3
3.6 Surge rating	3
4 INSTALLATION ADVICE	3
4.1 Where to install	3
4.2 Fusing MOVs	3
4.3 Residual current devices (RCDs)	4
4.4 SPDs with Generators	4
4.5 Insulation Testing	4
4.6 Annunciation	4
5 SURGE PROTECTION FOR DIFFERENT EARTHING SYSTEMS	4
5.1 What is the earth for?	4
5.2 Types of supply	4
5.3 Delta and wye supplies	5
6 MAINS SPD MAINTENANCE	6
6.1 Introduction	6
6.2 Fault finding	6
6.3 Field testing	6
6.4 Checking voltage-limiting component function	6
6.5 Checking series continuity	7
7 FREQUENTLY ASKED QUESTIONS	7

SURGE PROTECTION DEVICES FOR ELECTRICAL INSTALLATIONS

1 INTRODUCTION

This application note discusses the affects of surges and lightning induced overvoltages on ac power systems. The note will introduce the source of many common transients and surges and suggest the application of surge protection devices in this area. Finally, typical examples are shown for common installations

AC power protection is often overlooked when deciding a surge protection strategy. When providing protection, users are keen to apply surge protection devices, or SPDs, to process signal lines, transmitters, file servers and other important equipment as the source of surges is more obvious. However, a common source of surges is the AC power supply. It is important to note that any cable entering an electronic device is also a easy path for lightning current to enter and cause untold damage; the power supply is no exception.

2 HOW SURGES ARISE

Surges on the mains supply can come from a number of sources. The obvious route is via a lightning strike to the distribution system. In such a case tens of thousands of amps may flow through the electrical system and cause damage to sensitive electronics. Lightning may also induce currents into signal cables entering a building. Once inside the building they can easily couple into mains cabling. The opposite is also true; surge current in the mains system can also be coupled into data cabling. The only solution is to stop any surge current passing beyond the building entry.

Heavy current load switching can cause large surges on the supply either through inductive effects or due to the transformer's limited regulation. Lift motors and other large electrical machines can generate a significant number of surges, especially when the motor is worn. In a domestic situation, this is commonly seen when refrigerators or freezers switch on or off via their thermostats.

2.1 Expected surge levels

Many standards give an outline of the magnitude of current to be expected in various parts of a building. BS 6651:1999 splits the areas of a site into areas A, B and C with area C receiving the largest surges. Category C is on the supply side of an incoming power board, category B usually refers to the distribution board and category A represents the load side of a socket outlet. Each of these areas are split into exposure levels - low, medium and high.

With each of these examples, a peak voltage and peak current are given to which the SPDs should be tested. The largest surge - category C and high exposure - is given as 20kV and 10kA. In other words, the SPD should give protection up to at least 10kA. ANSI/IEEE C62.41-1991 gives recommendations on the protection level required. The document is very informative and shows measured waveforms and statistical data based on real installations. It also gives similar expected current values to those shown in BS 6651.

2.2 Location Categories - Zonal system

Several standards divide installation up into well defined zones in order to define what level of protection is appropriate for a particular area. IEC 61312-1 : Protection against lightning electromagnetic impulse (LEMP) Part 1 : Requirements of surge protective devices (SPDs) splits them into zones 0 to 3 with zone 0 expecting the highest surges and zone 3 the smallest. ANSI/IEEE C62.41-1991 ANSI/IEEE Recommended Practice on Surge Voltages in Low-Voltage AC Power Circuits uses categories A to C with category C containing the highest surges and Zone A the smallest. This category system is also used within BS 6651 Appendix C, with similar recommendations for protection levels.

2.3 ANSI/IEEE C62.41

ANSI/IEEE C62.41 is not a standard as such but a collection of recommendations for use with surge protection for AC supplies. It is actually very informative and gives plenty of real world data. This note tries to give realistic recommendations based on what really happens in installations instead of theoretical values.

2.3.1 Exposure levels

The exposure level can be found for an installation according to table 1. Most installations will fall into medium or low exposure levels unless they are particularly remote or in an area known for high levels of lightning activity. Both the exposure level and the category is required before deciding the level of protection appropriate for a given installation.

Table 1

Low Exposure	Systems in geographical areas known for low lightning activity with little load or capacitor switching activity
Medium Exposure	Systems in geographical areas known for medium to high lightning activity, or with significant switching transients. Both or only one of these causes may be present, as it is difficult to separate them in reviewing the results of monitoring disturbance.
High Exposure	Installations that have greater surge exposures than those defined by Low Exposure and Medium Exposure. The more severe conditions result from extensive exposure to lightning or unusually severe switching surges

2.3.2 Category definitions

Once the exposure level has been decided it is then a simple matter to decide the maximum surge levels expected for a particular installation. However, the surge levels within an installation may vary considerably from one area to another. See Table 2 Category C gives the highest expected surge levels as this area is exposed to the possibility of direct strikes or be close enough to direct strike for it to receive a large proportion of the strike.

The surge level decreases as it enters a building due to the impedance of internal wiring and connections. As the surge gets deeper into the building the surge impulse flattens out, becoming longer and with less current. Expected surge levels for different areas of the building are therefore much smaller within the building than at the entry.

It is interesting to note that areas over 20m from Category C are considered as being in Category A. As explained previously, this is due to the main cabling attenuating the surge level over its length, transforming it from a well defined high level impulse to a low current oscillating waveform.

Table 2

Category A	Outlets and long branch circuits All outlets more than 10m from Category B All outlets more than 20m from Category C
Category B	Feeders and short branch circuits Distribution panel devices Bus and feeder industrial plants Heavy appliance outlets with short connections to service entrance Lighting systems in large buildings
Category C	Outside and service entrance Service drop from pole to building Run between meter and panel Overhead line to detached building Underground line to well pump

2.3.3 Relevant tests

Table 3 shows the two main test waveforms and their relevance to the category areas. Not all tests are appropriate for each location.

Standard 1.2/50 and 8/20 Combination wave

The combination waveform is the main test wave used by surge protection manufacturers and contains a large amount of energy. It is a representative waveform referred to in many standards and allows the comparison of various protection methods. However, lightning strikes vary significantly in their

intensity from strike to strike and so test waveforms will give a 'rule of thumb' when comparing one SPD against another.

These waveforms are defined by their rise time, 1.2µs and 8µs respectively, and the time taken to decay to half of the peak value, 50µs and 20µs respectively, measured from the start of the wave. The 1.2/50 waveform is an open circuit voltage test whilst the 8/20 is a short circuit test. SPDs will always act as a short circuit to surges and therefore the 8/20 test is the most relevant for SPD testing. The difference in shape between the two waveforms can be explained by current flow through the mains cabling. Cable inductance slows the rise time of the 8/20 waveform but the huge current flow decreases the length of the waveform. The 1.2/50 waveform relies more on the natural rise and fall of the lightning impulse. Since no current flows, the rise time is not restricted by the cable inductance.

These tests are only relevant in Categories B and C as the long and therefore inductive path into Category A changes the waveform's shape and maximum current.

Standard 0.5µs 100kHz Ring Wave

This waveform differs from the majority of surge waveforms by having a high frequency ac component. Where a surge enters a building it is very similar to the 8/20µs waveform. However, by the time it has travelled along a length of mains cables and around a building the waveform changes significantly - the current has reduced and turned in to a decaying 100kHz wave. This 'ringing' effect is also very common when using ac power filters. The coils within the filter 'ring' at the resonant frequency of the circuit when a surge passes through it. For this reason, we would recommend the inclusion of a surge protection device with all filters.

The cable inductance of an installation also has the effect of reducing the surge current to a much lower level. Surge protection device fitted here should ideally not only clamp the transients to a safe level but also provide some form of filtering to remove the ring wave component.

These tests are only relevant in Categories A and B as Category C areas are too near the origin of the transient to have been affected by cable inductance.

Table 3

Location Category	Relevant tests	
	100kHz Ring Wave	Combination (1.2/50 & 8/20µs)
Category A	Yes	No
Category B	Yes	Yes
Category C	No	Yes

Table 4

Location Category	System Exposure	Peak Voltage (kV)	Peak Current (kA)
Category B	Low	2	1
	Medium	4	2
	High	6	3
Category C	Low	6	3
	Medium	10	5
	High	20	10

Table 5

Location Category	System Exposure	Peak Voltage (kV)	Peak Current (kA)
Category A	Low	2	0.07
	Medium	4	0.13
	High	6	0.20
Category B	Low	2	0.17
	Medium	4	0.33
	High	6	0.50

2.4 SUMMARY

This section has shown the effects of lightning-induced transients upon an installation. By identifying the exposure level and location category, the appropriate level of protection can be decided.

IEC61000-4-5 – Electromagnetic compatibility (EMC)

Part 4. Testing and measurement techniques. Section 4. Electrical fast transient/burst immunity test - Basic EMC publication

Mains driven equipment are likely to experience a number of differing stimuli from the power system. Among these are the surges generated by switching disturbances such as capacitor bank switching, load changes in the local power distribution system, resonating circuits associated with switching (e.g. thyristors) and faults such as shorts and arcs to the system earth. In addition, lightning strikes to nearby installations and mains supply systems will generate voltage surges. Manufactures need therefore, to be aware of the effects such surges have upon their equipment.

IEC61000-4-5 simulate both the voltage surges seen in the electrical distribution system and the surges experienced when the mains system is the victim of the near lightning strike. IEC61000-4-5 does not simulate a direct lightning strike onto the mains supply of the equipment under test (EUT), as the energy contained in a direct strike will normally have catastrophic results.

Two surge generators are described by IEC61000-4-5. The combination wave (hybrid) generator (1.2/50µs – 8/20µs) and the CCITT (10/700µs) generator. The former is required for general use. The latter is only required for testing communications equipment connected to telephone lines. The surge is a relatively fast pulse, which may pass through power supplies and directly affect both analogue and digital circuits.

Catastrophic results can include failure of semi-conductors connected to the mains (e.g. in switched mode supplies), or the pulse could pass through a linear PSU and affect devices in internal circuits. Injection of surges into the signal lines could affect the input/output devices, or arc across signal tracks. Minor effects, e.g. readings out of specification, reset or mode changes are often seen.

IEC61312 - "Protection against lightning electromagnetic impulse - Part 1: General principles" Gives information for the design, installation, inspection, maintenance and testing of an effective lightning protection system for information systems in or on a structure.

3 HOW DO I PROTECT MY INSTALLATION?

The previous section has described the expected surge levels for each installation, given an exposure level and location category. This section will detail the methods available to prevent damage through transient overvoltages.

3.1 Operation of a surge protection device

Surge protection devices (SPDs) only conduct under surge conditions. Normally, an SPD will do absolutely nothing, much as a fuse does nothing when it is used within its rating. However, once the voltage in the system rises due to the effects of a lightning strike, for example, the SPD starts to conduct and diverts the energy away from sensitive equipment. The surge or overvoltage only lasts for a short time, typically tens of microseconds to a few milliseconds, and so the total energy is not huge. Unlike a fuse, however, a surge protection device can be used many times.

3.1.1 Clamp voltage

All surge protection devices are triggered when the applied voltage rises above a given level. This is known as the clamp voltage and should be chosen to be higher than the mains voltage plus a margin. Figure 1 shows a surge imposed onto the mains. The limiting voltage of the SPD is represented by the dashed line and is above the peak value of the mains cycle to prevent the SPD conducting current when no surges are present. The shaded area shows the SPD clamping the overvoltage and preventing damage to sensitive electronic equipment. The current capacity of the SPD needs to be chosen to meet the amount of current expected in the given environment.

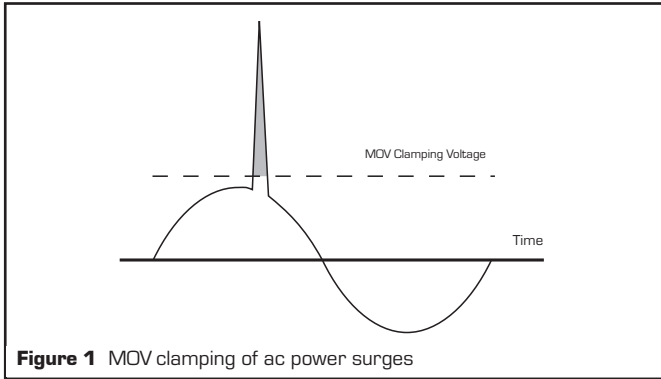

Figure 1 MOV clamping of ac power surges

The technology used to perform the clamping meets the following criteria:

- a) The surge handling is high enough for the application
- b) The clamp voltage is high enough to avoid the SPD clipping the supply continuously
- c) The SPD should switch off once the surge has passed

To have a sufficiently high surge rating, the devices are usually metal oxide varistors (MOVs) or spark gaps. MOVs have a high surge rating and are available in many different voltage ratings. Spark gaps have very high surge ratings but suffer from power follow-through. Once a spark gap operates it effectively shorts the supply and requires special design to switch off again. Standard gas discharge tubes should never be connected directly across the mains as they will normally never turn off. Some manufacturers have designed spark gaps which extinguish themselves shortly after the surge passes but may have a significant follow-through current for a period of time. In any case, these are coarse protectors and require finer protection devices in addition to reduce the surge level further.

MOVs, on the other hand, only clip the surge rising above the nominal supply voltage and turn off instantly once the surge has passed. A sufficiently rated MOV will meet all of the protection requirements for all installations.

3.2 Series or 'in-line' devices

In an ideal world we would always prefer to use series devices over parallel devices. These devices will always give the highest degree of protection as they can include noise filtering as well as surge protection. A combination of the two will provide a far cleaner mains supply than would be possible without the device. The main disadvantage of these devices is that, with the exception of low current devices, they can become very large as the full load current must be passed through the series elements. Devices are available with a rating of thousands of amps but these SPDs are very large indeed and require whole cabinets for themselves. Nevertheless, these SPDs will offer the best solution where the highest quality of the mains supply is essential.

3.3 Parallel or 'shunt' devices

These devices are wired in parallel to the supply and are available in a variety of surge ratings. Their main advantage over the series devices is that they only need to be rated for the surge current expected at the installation and not for the load current. This means that the same devices can be used in 32A systems as in 500A systems without the need for more cumbersome surge protection devices. Many different types are available, ranging from fully enclosed wall mount devices to individual SPDs for each phase.

3.4 Replaceable modules

Some units are available with replaceable surge modules. They are mounted onto busbar via their base and wired into the installation. Should any module fail, replacement simply involves pulling out the old unit and replacing with a new one. This process dramatically reduces the maintenance costs of such an installation. In addition, insulation testing of an installation is simplified as it does not require any rewiring of the SPD during testing.

3.5 RFI filtering

In some situations radio frequency interference may appear on electrical supplies, possibly by switching transients etc. Computer installations, for example, can be susceptible to interference on their supply where it may cause corruption of data or other apparently unexplained behaviour. Surge protection devices will easily remove any transients which are sufficiently large to cause the SPDs to conduct. However, interference below this level can still cause problems with computer installations.

RFI interference filters are readily available from a number of manufacturers. Whilst these will easily reduce the level of interference by a significant amount they can also introduce further problems into the installation. When a high energy surge enters a filter it can cause an effect called 'ringing'. The impulse can cause the filter to oscillate and produce a high frequency wave of a potentially damaging amplitude. It is important, therefore, to ensure surge protection is always provided with mains filtering devices, preferably within the same enclosure.

3.6 Surge rating

Much of the literature published by the various surge protection device and component manufacturers makes use of the terms multi shot and single shot. Component manufacturers generally quote the multi shot rating which is the current withstand rating of the device for ten applications. Additionally, they may also quote a larger figure known as the single shot rating. This may be at least twice that of the multi shot rating.

In many cases the manufacturers' quoted values can be on the conservative side. For example, varistors rated at 6.5kA single shot can withstand surges of at least 8kA with no significant degradation in performance. As the magnitude of the surge decreases, the lifetime increases dramatically. A single 20mm varistor can survive many hundreds of tests at 1kA.

4 INSTALLATION ADVICE

4.1 Where to install

The usual place to install an SPD is in the distribution panel. When installing parallel devices, the length of the spur from supply to the SPD and from the SPD to earth are critical. An excessive length from the SPD to earth will add a common mode voltage to all of the phases. We would recommend keeping the cable lengths less than one metre where practical.

4.2 Fusing MOVs

Metal oxide varistors used within a surge protection device should give many years of service. However, when used in an area of high lightning activity or where surges are a regular occurrence, SPD lifetime can be reduced. When the MOV has come to the end of its life it becomes a low impedance and consequently draws a considerable amount of current. Although many surge protection devices contain their own internal fusing, many standards recommend the fitting of external current limiting as an additional safety feature.

4.2.1 Upstream or downstream?

There is often confusion over where SPDs should be fitted in relation to any current limiting devices. When fitted upstream of the fuse or MCB they protect the devices from the effects of any surge on the supply. However, the SPD will need to rely upon its own internal fusing or have additional protection fitted. When fitted downstream of the fuse the surge current will have to pass through the main fuse or MCB with the possibility of supply and SPD disconnection.

4.2.2 Fuse selection

The fuses recommended for use with SPDs are not installed to protect the SPDs, they are used to protect the mains from the SPDs if they fail due to a huge lightning strike or overvoltage. A fuse that is small enough to protect the SPD (less than 1A) would fail as soon as a reasonably large surge came into the system. For this reason, large motor rated fuses or similar are usually recommended as these are designed to withstand the surges associated with motor starting. The actual value of this fuse will vary depending upon the surge rating of the SPD.

In some cases the supply's own fuses can be used as long as they have the required rating. In larger current supplies it is necessary to install a separate fused spur for the devices. This installation method has the additional benefit of allowing the continued supply of current to the installation. However, it should be noted that the MOV element will be disconnected from the supply and hence SPD replacement is necessary for further protection.

4.2.3 MCB equipped installations

Many installations now use MCBs or miniature circuit breakers in preference to fuses. Whilst being more convenient than fuses, MCBs can add inductance to the circuit and hence increase limiting or limiting voltages. They also need to be capable of handling very large surge currents without damage or disconnecting the SPD erroneously.

4.2.4 Preferred installation

We would therefore recommend the use of a fused spur. This installation has the advantage of isolating the MOVs from the supply without disconnecting

the supply from the MCBs. It also means that the fuses used with the MOVs can be more suited for the MOVs instead of being selected purely for the system load.

4.3 Residual current devices (RCDs)

The correct placement of RCDs in a circuit will determine the effectiveness of the SPD installation. RCDs measure the amount of current flowing to earth from a supply and disconnect the supply when this current reaches a set value. Commonly, this value is set at 30mA as a current flow greater than this through a person is life-threatening.

Installing an RCD upstream of a surge protection device exposes the RCD to the full surge current and lead to possible welding of contacts. Such currents will, at the very least, cause the safety critical device to become unreliable. Additionally, placing the RCD upstream of the surge protection device may result in the RCD disconnecting the surge protection device and supply during a surge. This may be due to the large current flow to earth during a surge or from the generation of back EMFs from inductive load switching.

4.4 SPDs with generators

Mains Surge Protection Devices or SPDs are generally made of MOVs or metal oxide varistors which are designed to start conducting at a specified voltage. They are rated at the maximum allowable mains voltage plus an extra 10 or 20% safety margin to allow for any variability in the varistor's voltage.

When the applied voltage rises above the varistor voltage, a large current starts to flow through it. Varistors are very good at absorbing huge transients such as those caused by a nearby lightning strike where many 10s of thousands of amps may flow for less than a thousandth of a second. The energy passes very quickly and the varistors are allowed to cool before the next transient.

However, when the mains voltage increases above the maximum allowable limit, the varistors start to conduct mains current almost continually and get very hot. This may cause fuses to blow and possibly damage the SPD.

When used with a generator, regulation of the generator output voltage must be sufficient to prevent large variations in the output voltage. SPDs will remove transients from the output and prevent damage to sensitive equipment but will not regulate the output voltage.

4.5 Insulation testing

Many installations are insulation-resistance tested to ensure the installation is safe and all wiring has been done correctly before power is supplied to the system. This involves applying a high voltage to the wiring and ensuring a large current flow does not occur. However, since surge protection devices are designed to conduct when high voltages are applied to them, it will give the appearance that the wiring is at fault. If insulation testing is necessary, it should either be carried out before the surge protection devices are fitted or, in the case of individual SPD modules, the surge protection units should be removed from their base before testing begins.

4.6 Annunciation

Some SPDs include some form of status monitoring. This may range from a simple mechanical flag, counter or LED to a comprehensive system of volt-free contacts and audible sounder. These intend to give a warning that the SPD has come to the end of its useful life and requires replacing. In the modern surge protection systems, an optical monitoring system may be used. This comprises of a separate 'control module' which transmits an infrared signal through an aperture in the SPD devices mounted on the same DIN rail. The 'controller' can normally monitor up to 15 modules.

5 SURGE PROTECTION FOR DIFFERENT EARTHING SYSTEMS

There are many earthing configurations possible when designing an installation. The differences will occur depending upon local regulations or particular installation policies or preferences. The reader should consider their local regulations when designing the earthing system for their needs. Further information regarding surge protection device earthing can be found in Application Note TAN1003 which covers the subject in greater detail.

5.1 What is the earth for?

From an installer's point of view, earthing serves the purposes of:-

- Blowing fuses should a fault occur. A low impedance earth connection is essential for fuses to blow reliably
- Ensuring all exposed metalwork is at the same potential and hence preventing shock hazards

It is important to note that systems which work perfectly for mains frequencies may require modification to achieve the best surge protection. The main difference between surge protection requirements and standard safety practices are;

- Surges of many thousands of amps can easily produce large voltages across earth cabling. For example, an earth cable measuring 0.1 ohms from one end to the other and with 10kA flowing through it will cause a voltage across the cable of 1000V.
- The high frequency component of a lightning strike makes the inductance of an earth link or bond to become more important than the resistance. A voltage of 100V per metre of cabling per thousand amp surge is common, purely due to the cable inductance.

These considerations mean that connections considered to have no resistance can quite easily cause many thousands of volts to appear across earth bonds.

5.2 Types of supply

There are a number of methods by which an earth connection can be given and there are now standard definitions for these in Europe. They are each identified by a coding which contains the following letters:

- T: terre, direct connection to earth
- N: neutral
- C: combined
- S: separate

Most of the systems discussed here approach electrical safety in a different way. In some situations, for example an area with very low soil conductivity, the choice of earthing systems may be very narrow but others leave a wider range of possibilities. It is important to note that these systems are not specifically designed for surge protection purposes and for this reason suggestions are made for optimum surge protection performance.

5.2.1 TN-C system

In this system, the neutral and protective earth are combined in a single conductor throughout the system, known as the Protective Earth and Neutral conductor (PEN). At the distribution board the neutral is bonded to the local earth and from that point forms the earth connection for the installation. This has the advantage of saving the electrical suppliers the cost of an extra conductor. More importantly, it gives a far lower impedance to the local earth than there would be to the neutral starpoint.

Surge protection considerations

Surge protection devices should be installed at the distribution board with protection from phases to the PEN.

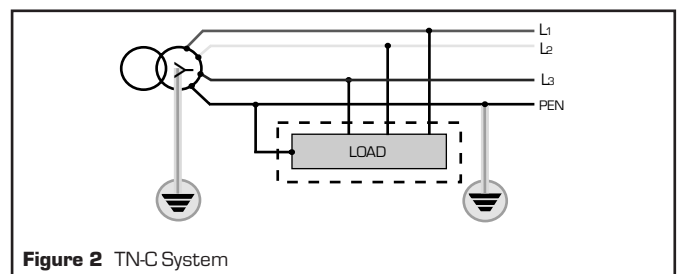

Figure 2 TN-C System

5.2.2 TN-S system

In this system, the neutral and protective earth are separate conductors throughout the system. Unfortunately, this is difficult to provide. As the distance from the neutral starpoint increases, so does the earth impedance. Fault currents flowing from one installation can cause a voltage drop from the earth at that installation to the earth at another installation. Hence the concept of providing an equipotential earth connection is difficult to achieve.

Surge protection considerations

Surge protection devices should be installed at the distribution board with protection from phases to earth and from neutral to earth. An additional connection to a local earth is also advisable as the difference in potential between local earth and the PEN during a lightning strike can be significant.

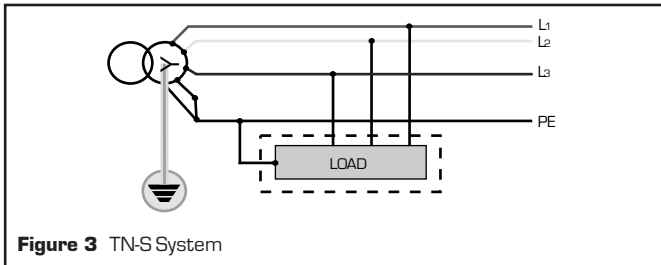

Figure 3 TN-S System

5.2.3 TN-C-S system

In this system, the neutral and protective earth are combined in a single conductor in only part of the system. At the distribution board the neutral is bonded to the local earth and from that point forms the earth connection for the installation. This has the advantage of saving the electrical suppliers the cost of an extra conductor. More importantly, it gives a far lower impedance to the local earth than there would be to the neutral starpoint.

Surge protection considerations

Surge protection devices should be installed at the distribution board with protection from phases to earth and from neutral to earth. This ensures that all of the power cables are safely clamped to the local earth potential.

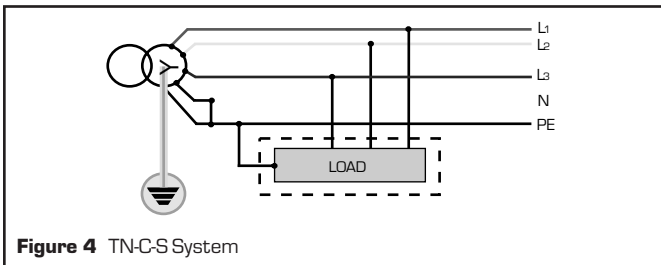

Figure 4 TN-C-S System

5.2.4 TT system

In this system, the power source is earthed at one point and there is a separate safety earth for the installation derived from an electrically independent electrode. The earth connection used in the installation is provided by earth mats or rods and this connection is not bonded to the installation's neutral connection.

Surge protection considerations

Surge protection devices should be installed at the distribution board upstream of any RCDs with protection from phases to neutral. An additional surge protection device should also be fitted from the neutral connection to the local earth connection. The SPDs will then clamp surges relative to the local earth potential and prevent flashover from earthed enclosures to electronics.

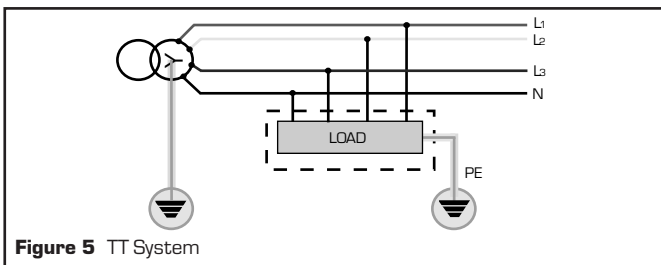

Figure 5 TT System

5.2.5 IT system

In this system, there is no direct connection between neutral and earth and there is a separate safety earth for the installation. There is an earth impedance from the neutral starpoint to its local earth, either introduced deliberately or by virtue of a low soil conductivity. Unusually, the supply to the installation does not contain a neutral connection. Instead, loads are connected from phase to phase. This sort of installation is common where a 'far' ground connection cannot be relied upon, for example in swimming pools. Here, we would rather use an earth connection near the pool itself than use a long connection to the neutral starpoint - a break in this connection could be lethal.

Surge protection considerations

From a surge protection point of view, we are concerned about the potential difference between the phases and the ground on which we are standing. For this reason, surge protection devices should be installed at the distribution board with protection from phases to the local earth. Consideration should be given, however, to the affect of any imbalances in the phase voltages. Specially designed SPDs are preferred which will not be affected by imbalances or possible insulation errors.

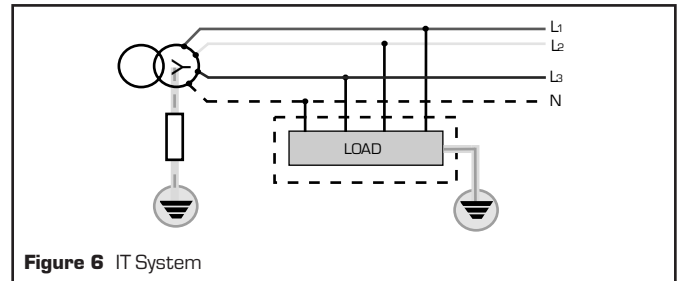

Figure 6 IT System

5.3 Delta and wye supplies

By far the most common supply system is the wye or star system. This allows a central neutral reference voltage to be created which is normally earthed at one or more points in the system. In such a system, all phases have the same nominal voltage with respect to the neutral but with a phase difference of 120°. Generally, this 'neutral starpoint' forms the earth connection for TN-S systems.

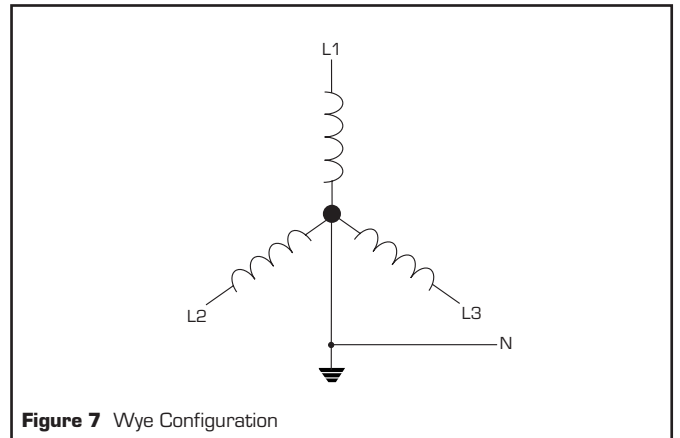

Figure 7 Wye Configuration

In a European IT system, the configuration is the same as the Wye but may not have the earth connection.

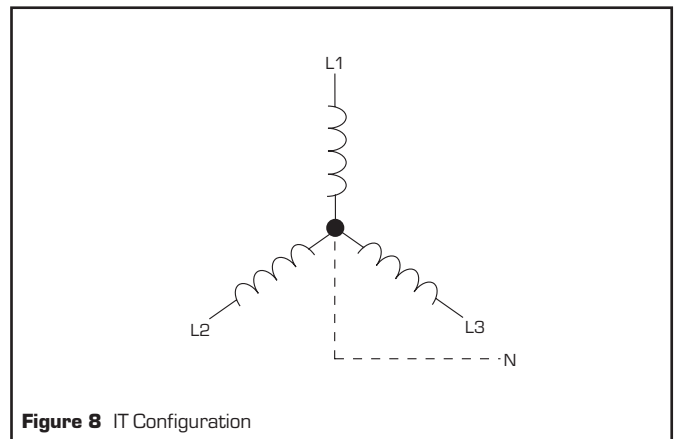
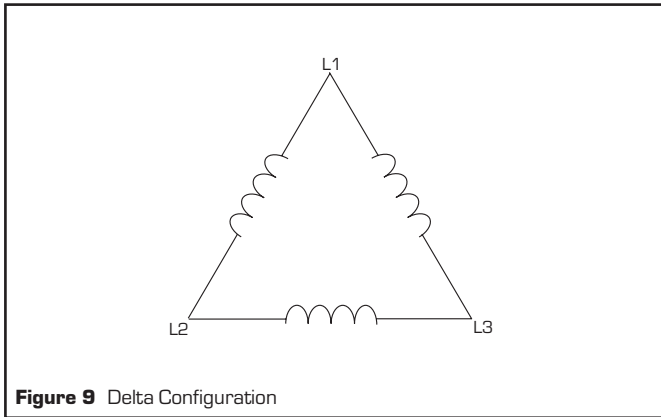

Figure 8 IT Configuration

The configuration of the Delta power systems are similar to the European IT system but with the three phase winding in a different configuration, as shown in the diagram below, where there is no neutral and the phase outputs are floating. The Delta system therefore has no direct connection between the phases and earth (ground), with only the exposed conductive parts of the installation being earthed for safety reasons. Unearthed or insulated systems such as the Delta and IT systems with no connection to earth do have some advantages over the wye configuration, in that, if there was a single fault to earth, no significant current would flow. A second fault however would cause significant damage.



6 MAINS SPD MAINTENANCE

6.1 Introduction

No regular maintenance or operational checks are needed for most SPDs. Any faults which may develop are likely to be self-revealing in that the devices will fail to earth with either open-circuit lines or short-circuit lines. These are both 'fail-safe' in nature as system damage cannot be caused with subsequent surges or overvoltages. System operation is, of course, interrupted if an SPD fails but this should not happen often, MTBF to RRE250 is well in excess of 200 years. After surge diversion, Telematic SPDs automatically reset to the passive protection mode.

It is however advisable to check the earth connections periodically to make sure no deterioration has taken place and that no modifications or additions have been made which bypass the SPDs. SPD installations will only be effective if all possible entry points of overvoltage and surge currents are secured. A comprehensive and knowledgeable approach to lightning protection is needed and it should be the responsibility of one nominated individual on each site. He/she will need the wisdom of Solomon (or the beauty of the Queen of Sheba) and a highly developed sense of diplomacy to be able to overrule the 'earth' requirements of the computer department, the instrumentation department, the electrical department, etc., and anyone else who 'knows what earthing is all about'. Some suitable test procedures for checking earth connections are included in TAN1003. In a general sense, the simple tests described in this publication may also prove useful.

6.2 Fault finding

Before installation, the end-to-end resistance across an SPD can be checked simply with an ordinary multimeter applied on one of the resistance ranges. This should not exceed 50 ohms for any Telematic unit and will be noticeably lower for some. Another check is to measure the resistance between lines and line-to-earth. This resistance will be very high unless the protection element has failed safe or the meter output voltage is greater than the rating of the SPD (unlikely for most SPDs).

Once units are installed, commissioned and working, frequent checking is not recommended for any SPDs. Faults are generally self-revealing through loop malfunction. In any installation except the simplest, there is a very real chance that disconnecting and reconnecting large numbers of wires from SPDs to perform routine testing can lead to crossed wires or misconnections. Reversed polarity will not damage the SPDs (which are generally symmetrical about earth) but it may cause problems for the protected equipment.

6.3 Field testing

The following checks can be made, with the help of a multimeter:-

- For an in-line SPD, the voltage-limiting component function (section 6.4) and series continuity (section 6.5)
- For a parallel (or 'shunt') SPD, the voltage-limiting component function (section 6.4)

It is usually neither practical nor necessary to test the RFI filter characteristic.

6.4 Checking voltage-limiting component function

These tests can be applied to both in-line and parallel SPDs.

6.4.1 Checking resistance

The simplest and safest method is to disconnect the SPD from the supply and use a multimeter to check varistor failure by measuring the resistance between the live-neutral terminals (figure 10) and the live-earth and neutral-earth terminals (figure 11 and 12). The live-neutral resistance should be close to 1Mohm, the value of the safety bleed resistor; a significantly lower resistance indicates probable varistor failure. For the live-earth and neutral-earth checks, the resistance should normally exceed 10Mohm.

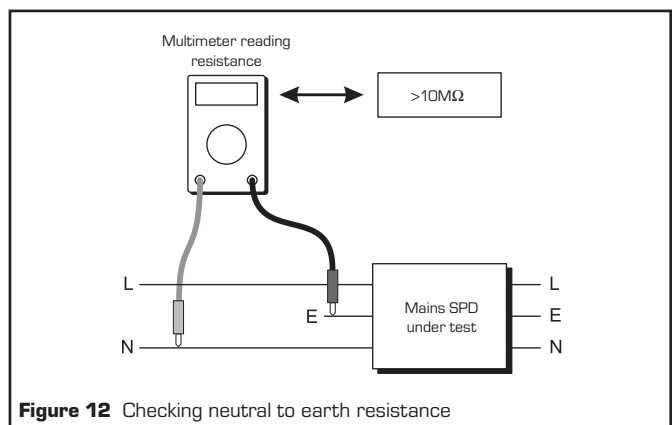
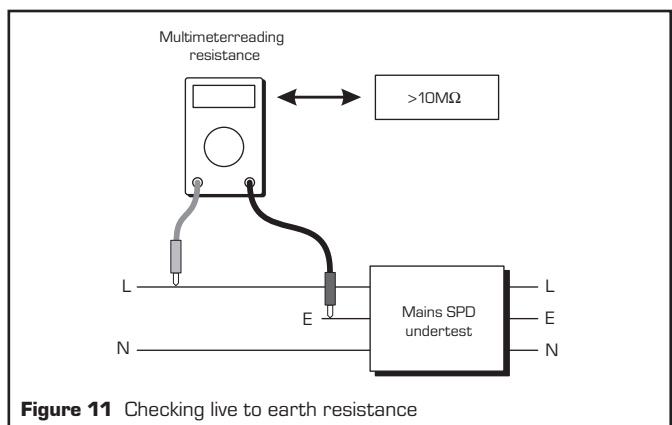
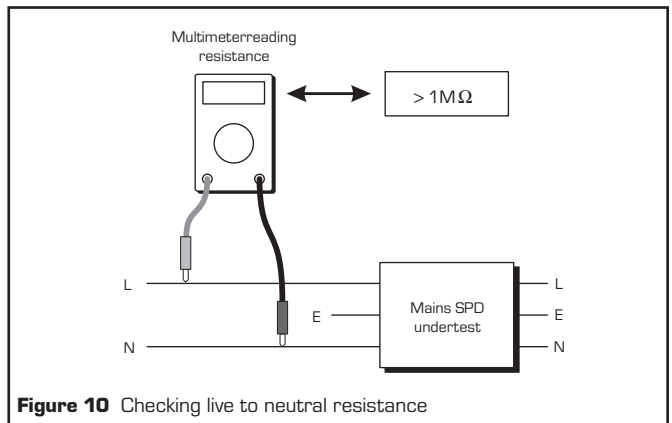

6.4.2 Checking leakage current

The no-load current consumption can be checked with the circuit shown in figure 13. This provides a more definitive indication of possible component failure but is potentially less safe to apply.

Note: this test MUST only be performed by competent personnel taking all necessary precautions - including the ESSENTIAL use of the safety isolation transformer indicated in the diagram.

6.4.3 Checking low-current limiting voltage

If a high-voltage low-current source (or test set) is available, an accurate assessment can be made of the voltage-limiting components by measuring their low-current limiting voltage as shown in figure 13.

Note: a suitable high-voltage low-current source is provided by an insulation tester providing at least 500V current limited at approximately 1mA.

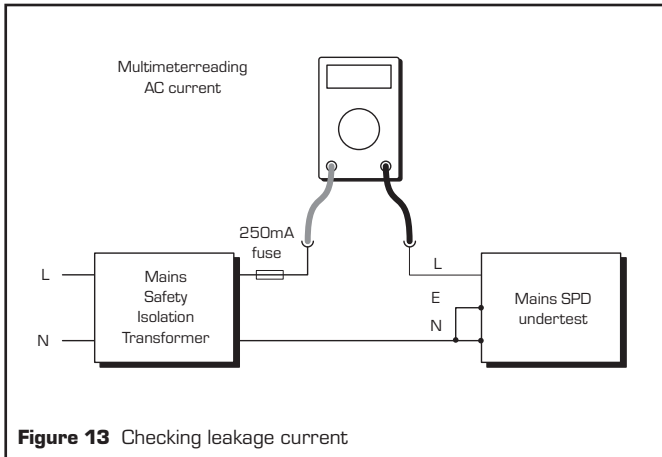

Figure 13 Checking leakage current

6.5 Checking series continuity

This test can only be applied to in-line SPDs.

Continuity is checked (see figure 14) by using a multimeter to measure resistance between the input and output terminals (i.e., live-live and neutral-neutral). Allowing for meter lead resistance, this should be less than 1 ohm.

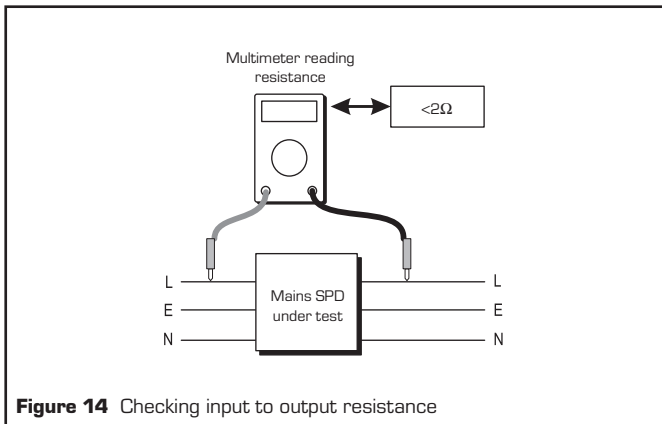

Figure 14 Checking input to output resistance

7 FREQUENTLY ASKED QUESTIONS

Q: Do you have any advice for using surge protection devices with generators?

A: When used with a well regulated generator, surge protection devices provide a high level of protection for sensitive equipment. However, if the generator output voltage increases above the SPD's maximum allowable limit, the varistors start to conduct mains current on each half-cycle of the supply and get very hot. This may cause fuses to blow and possibly damage the SPD. If regulation is poor it may be necessary to use an SPD designed for a higher voltage supply, for example using a 480V device on a nominal 415V system.

Q: My transformer is rated at 63kA short circuit and yet the surge protection device I have is rated at less than this. Do I require an SPD with a larger current rating?

A: When a transformer is short circuited, a large current flows due to the small impedance of the supply. Under these circumstances the transformer should be capable of providing this short circuit current until the supply is disconnected. Transformers, therefore, need to comply with a specified current rating based upon the expected magnitude of short circuit current. Surge protection devices are also specified to meet expected surge currents in an installation to ensure adequate protection for any equipment connected to the supply. The expected currents for the transformer and surge protectors are based on real but different measurements.

Q: My surge protection device is rated at 10kA and yet is very small and uses very thin wires considering the current rating. Surely the device isn't sufficiently rated?

A: Surge protection devices only operate for a very short time and so there is not enough time to damage the cables.

Q: I have heard that varistors have a limited life. How do I know how long my SPD will protect my equipment?

A: In the low resistance state, varistors can pass large currents, of the order of kiloamps, for a very short time (of the order of 10 microseconds), while limiting the voltage across them. However, they are only able safely to dissipate quite modest continuous power, in the region of a watt or so. If subjected to a continuous mains over-voltage they rapidly heat up. As they do so, their clipping voltage drops, the current increases further, and they enter thermal runaway, either blowing the series supply fuse or exploding if they are not adequately fuse-protected. In instances where the supply fuse blows, the device package sometimes still ruptures with an audible popping sound.

Varistors also "age" when subjected to a large number of heavy surges. Their clipping voltage falls after each surge, which actually increases the degree of protection afforded. When it falls within the peak of the mains cycles, thermal runaway and rapid failure ensue. The factors which govern the service lifetime of a varistor are:-

- Robustness of the varistor. This is attributed to the surge rating of the device in kA and is related to the physical size of the device.
- Clipping voltage relative to supply voltage. The bigger the difference, the poorer the protection, but the longer the device will last.
- Number of surges
- Energy content of surges (a function of current and time).
- Time between surges. Where varistors are allowed to cool between surges their lifetime is increased significantly.

To ensure an effective surge protection regime, the SPD should be sufficiently rated in terms of working voltage and surge current for the application. Remote annunciation or a status indicator will give sufficient notice for SPD replacement to avoid leaving an installation unprotected.

Q: How do I read the surge rating figures? Some requirements want a 20kV SPD but yours are rated at 10kA.

A: Many standards list expected peak voltages and currents for given location categories. Sometimes there is concern over the voltage rating of a surge protection device when many manufacturers tend to state only the peak current for the units. The peak current is by far the most appropriate method of specifying surge protection devices for the following reasons;

- The wave forms quoted in these standards are purely representative wave forms for testing SPDs. The voltages quoted are an indication of the voltage required to provide the specified current and depend upon the type of surge generator necessary. In each table you may note that the source resistance for each value is the same for each system exposure and again is due to the type of surge generator used.
- Lightning can be considered as a huge current source. Voltages of around 100 million volts are available which makes the current impossible to stop. With such a large driving force behind it, the current will spark over gaps in its path to earth and the voltage is largely irrelevant.
- Where SPDs are installed it is impossible to generate the voltages quoted across the SPD. If it were possible, the SPD would be useless. For example, a varistor will only allow several hundred volts across it before it starts conducting. At this point the voltage across the varistor remains fairly constant and many thousands of amps can flow through the device to earth. The capacitors in the surge generator will still have a huge voltage across them but the voltage across the varistor and therefore the protected equipment is very low.

Telematic Limited

Pondwicks Road, Luton, Beds, UK LU1 3LH
Tel: +44 (0)1582 429464 Fax: +44 (0)1582 459669
E-mail: enquiry@telematic.com WWW: www.telematic.com

A member of the MTL Instruments Group plc

Atlantic Scientific Corporation

4300 Fortune Place, Suite A, W. Melbourne, Florida 32904 USA
Tel: +1 321 725 8000 Fax: +1 321 727 0736
E-mail: sales@atlanticscientific.com WWW: www.atlanticscientific.com

A member of the MTL Instruments Group plc