

F300 megablock range

MTL fieldbus device couplers



Declaration of Conformity

A printed version of the Declaration of Conformity has been provided separately within the original shipment of goods. However, you can find a copy of the latest version at <http://www.mtl-inst.com/certificates>

CONTENTS

	DECLARATION OF CONFORMITY	II
	GENERAL SAFETY INFORMATION	IV
1	OVERVIEW	1
2	DESCRIPTION	1
3	COMPONENTS AND ACCESSORIES	2
4	MECHANICAL	2
4.1	Mounting orientation	2
4.2	Enclosure requirements	2
4.3	DIN-rail mounting	3
4.4	Removal from DIN-rail	3
5	ELECTRICAL CONNECTIONS	3
5.1	DC Power Requirements	4
5.2	Terminator	4
5.3	Trunk connections	4
5.4	Spur port connections	5
5.5	Cable screen connections	5
5.6	Surge protection	5
6	TESTING	6
6.1	Power LED	6
6.2	Spur LEDs	6
7	ROUTINE MAINTENANCE	6
8	ATEX SAFETY INSTRUCTIONS	7
8.1	General	7
8.2	Installation	7
8.3	Inspection and maintenance	7
8.4	Repair	7
8.5	Marking	8
9	FM CONTROL DRAWINGS	9
10	IECEX SAFETY INSTRUCTIONS	12
10.1	SPECIFIC CONDITIONS OF USE	12
10.2	IECEX Control drawings	13-16
11	CCC INSTRUCTIONS	17-20

GENERAL SAFETY INFORMATION

The following methods are used in this manual to alert the user to important information:-

	WARNING ! Warnings are provided to ensure operator safety and MUST be followed.
---	--

CAUTION Cautions are provided to prevent damage to the instrument.
--

NOTE These are used to give general information to ensure correct operation.
--

SAFETY INSTRUCTIONS FOR INSTALLATION AND OPERATING PERSONNEL

The operating instructions provided here contain **essential safety instructions** for installation personnel and those engaged in the operation, maintenance and servicing of the equipment.

	WARNING ! Failure to comply with these instructions can endanger the lives or health of personnel and risk damage to the plant and the environment.
---	--

	WARNING ! The responsibility for planning, installation, commissioning, operation and maintenance, particularly with respect to applications in explosion-hazard areas, lies with the plant operator.
---	--

Before commencing installation or commissioning:

- Read and understand the contents of this manual and the product datasheet
- Ensure installation and operating personnel have received adequate training for this task
- Ensure that any operating instructions are fully understood by the personnel responsible.
- Observe national and local installation and mounting regulations (e.g. IEC 60079-14).

	WARNING ! If these assemblies have been used previously in general electrical installations, they MAY NOT be used in explosion-hazard area applications.
---	---

During operation:

- Make the relevant instructions available at all times to the operating personnel.
- Observe safety instructions.
- Observe national safety and accident prevention regulations.
- Operate the equipment within its published specification.
- Servicing, maintenance work or repairs not described in this manual must not be performed without prior agreement with the manufacturer.
- Any damage to this equipment may render its explosion protection null and void.
- No changes to any of the components that might impair their explosion protection are permitted.

If any information provided here is not clear:

- Contact Eaton's MTL product line or one of its representatives.

NOTE Improper installation and operation of the enclosure can result in the invalidation of the guarantee.
--

F300 megablock range MTL Fieldbus device couplers



Figure 1.1 - Megablock models F312, F308 and F304

1 OVERVIEW

F300 Megablocks are DIN-rail mounted, device couplers for FOUNDATION™ fieldbus or Profibus PA networks. They allow connection of field devices to the segment trunk cable and provide short-circuit protection to the segment.

Megablocks minimize hand wiring and allow individual devices to be added to and removed from the segment without disrupting network communication.

Megablocks are available in four, eight, and twelve port versions. Multiple Megablocks are easily wired together to allow larger segments to be constructed.

Each F300 Megablock includes an F97 Terminator for installation in the trunk terminals, which is clearly marked with a large 'T' for easy identification by field personnel.

Individual surge-protector modules (FS32) can also be fitted to any of the Megablock fieldbus terminals to provide protection against induced surges and transients that can potentially destroy or degrade certain components inside the F300 Megablocks.

2 DESCRIPTION

Simple and reliable interconnection

Each Megablock has dedicated connections for the fieldbus “home run” or trunk cable. Trunk connections are identified by their black connectors. Numbered (grey) connectors are provided for each spur.

Wiring connections to the Megablock are made using pluggable connectors (screw terminal type are standard, but other connection styles are available). These allow wire terminations to be made to the individual connectors, which are then plugged into the Megablock. Devices can be connected and disconnected easily during commissioning. On completion, the connector retaining screws are tightened to secure each connector to the Megablock.

Short-circuit protection

To minimize susceptibility to single points of failure, F300 Megablocks are provided with built-in SpurGuard™ short-circuit protectors, which prevent the entire Fieldbus segment from being pulled down in the event of a short circuit on any one of the individual field devices or spur cable runs.

NOTE

During a short circuit, the shorted spur draws more current than a normal Fieldbus device - this must be taken into account in segment design.

Diagnostic aids

Each Megablock comes with a green LED to indicate whether DC Power is present, and a red LED next to each numbered spur indicates when the spur is in short circuit.

3 COMPONENTS AND ACCESSORIES

Product part numbers and their descriptions are listed below.

Part Number	Description
F304[-PC]*	4-way Megablock
F308[-PC]*	8-way Megablock
F312[-PC]*	12-way Megablock
F97	Terminator for F300 range of Megablocks
F300-A01-5	Trunk-spur partition – pack of 5
FS32	Spur surge protector module
F300-BAR-5	FS32 grounding bars for trunk - pack of 5
F304-BAR-10	FS32 grounding bars for F304 - pack of 10 †
F308-BAR-10	FS32 grounding bars for F308 - pack of 10 †
F312-BAR-10	FS32 grounding bars for F312 - pack of 10 †

* The standard connector for the Megablock is a pluggable screw terminal (elevator type). Pluggable spring-clamp connectors rely on constant spring pressure to maintain contact with the wire. To order Megablocks with pluggable spring-clamp connectors, add a -PC suffix to the part number (i.e. F304-PC).

† Up to two bars may be required for each Megablock.

4 MECHANICAL

4.1 Mounting orientation

Megablocks mount vertically or horizontally on 35mm DIN rail within a field junction box. The use of DIN rail end stops are recommended to prevent sliding (especially for vertical installations).

Eight, and twelve port Megablocks have areas on their body for labelling so that segments can be easily identified according to plant standards.

4.2 Enclosure requirements

4.2.1 General requirements

Megablocks may be mounted in hazardous (classified) areas – see section 8. The following conditions must also be satisfied to ensure safe and reliable operation.

- Prevent any form of pollution that could compromise the operation of the unit. For example, choose an unpolluted location or a suitable enclosure to protect the assembly.
- Provide an adequate level of mechanical protection. This can be achieved by selecting a protected location, a suitable enclosure, or a combination of both.
- Ensure that all cable entries and connections are secure by making provision for the careful routing and securing of all cables.

- d) Provide adequate security against unauthorized interference.
- e) Conform to the permitted ambient temperature range of -45°C to $+70^{\circ}\text{C}$.

4.2.2 Outdoor mounting

In addition to the General Requirements above, if the Megablock is mounted in an outdoor location, use a suitable enclosure with a minimum of IP54 ingress protection. A higher level of ingress protection rating will be necessary if the working atmosphere is, or can be, corrosive, or if the enclosure is subject to wet or dusty environments.

4.3 DIN-rail mounting

The Megablocks are designed for mounting on 35mm x 7.5mm T-section “top hat” DIN rail to EN50022 and use built-in DIN rail clips to attach to the rail.

4.3.1 Mounting procedure

Megablocks are attached to the DIN rail using a “push-and-tilt” method- as illustrated on the body label and in Figure 4.1 below.

Tilt the Megablock towards the trunk-connector side of the Megablock and then engage the DIN-rail clips under the ledge of the DIN rail. Push the Megablock against the edge of the rail then rotate the Megablock until it sits flat onto the DIN rail, then release the pressure to allow the clips on the other side to engage.

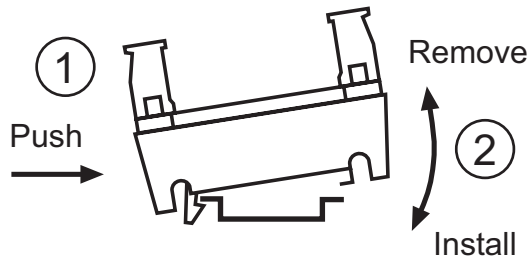

Figure 4.1: DIN Rail Installation and Removal

4.4 Removal from DIN-rail

Referring to Figure 4.1, push the Megablock against the edge of the DIN rail, tilt the other side of the Megablock up and away from the DIN rail, then release the side pressure to disengage the DIN rail clips from the DIN rail ledge.

5 ELECTRICAL CONNECTIONS

The Trunk and Spur connectors are pluggable (with securing screws) and available in the standard screw-terminal version or a spring-clamp version. Megablocks with spring clamp connectors have a -PC suffix on the Megablock part number (-PC). See Figures 5.1 and 5.2. The terminals can accept the following conductor sizes:

Type	Conductor size
Screw terminals	0.14 to 2.5mm ²
Spring clamp terminals (-PC)	0.20 to 2.5mm ²

NOTE

A torque screwdriver set between 0.5 - 0.6Nm is recommended for tightening all terminal screws.

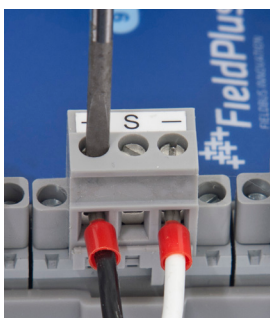

Figure 5.1: Screw Terminal

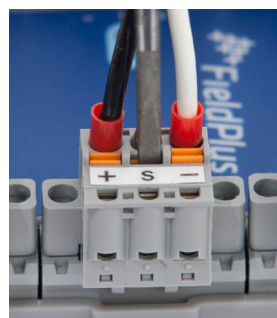

Figure 5.2: Spring Clamp

NOTE

When wiring to spring-clamp terminals, use a screwdriver with a 3-4 mm blade to depress the spring-clamp button before inserting the termination cable. See Figure 5.2.

5.1 DC Power Requirements

Megablocks draw DC power from the fieldbus trunk segment they are connected to. The minimum DC input voltage, and current required, vary with the Megablock type. Refer to the F300 datasheet for exact current requirements. The maximum input voltage is 32V DC, but a lower voltage may be required in order to achieve safety in some hazardous area applications- refer to the Control Drawings in Sections 9 & 10 of this manual.

5.2 Terminator

A terminator (Model No. F97) is provided with each F300 Megablock. The terminator should be installed on the trunk of the last Megablock in order to correctly terminate the bus. The terminator is placed in the second set of terminals on the trunk connector.

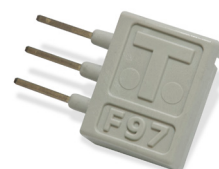

**Figure 5.3
F97 terminator**

For spring clamp terminals, push the terminator firmly into place. **Take care** to orientate the terminator so that the “T-F97” molded logo is facing *inwards* towards the body of the Megablock, otherwise difficulty will be experienced in accessing the spring-clamp buttons to remove it. For screw terminals, loosen the screws, insert the terminator so that the molded logo is visible and then tighten the screws. The F97 terminator has no specific polarity but inserting it with the ‘T’ visible clearly identifies the component, and its purpose.

When not in use, the F97 should be stored in the convenient storage slot provided in the F300 body close to the trunk connection (Figure 1.1 shows it mounted this way on the F304 model).

5.3 Trunk connections

Each trunk connector provides two sets of interlinked (+), (-) and cable screen (S) connections.

The second connection enables the user to onward connect the trunk to a further Megablock and avoids breaking the connection if an “upstream” Megablock needs to be removed.

The second connection can also be used, as mentioned above, to install the F97 terminator if it is the last Megablock on the segment. See Section 5.5 for information on cable screen grounding.



WARNING !

It is not permitted to connect or disconnect the trunk wiring in a hazardous area without a gas clearance certificate or unless the circuit to which it is connected has been de-energised.

5.3.1 Ex nA [ic] & Ex ec [ic]

When the equipment is installed in an Ex nA [ic] or Ex ec [ic] application, a trunk-spur partition* must be installed to segregate the trunk and spur wiring- see Figures 5.4 and 5.5.

* available in packs of five as Part No. F300-A01-5

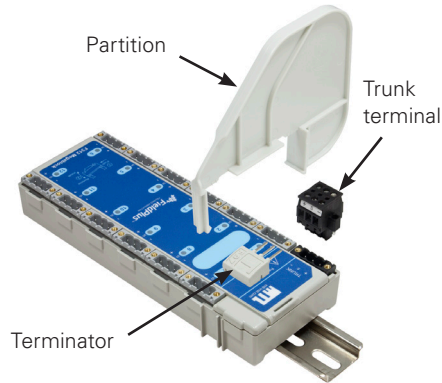

Figure 5.4: Trunk-Spur partition installation



Figure 5.5: Trunk-Spur partition in position

Position the partition as shown in Figure 5.4 and locate the fingers into the channels on the sides of the device body. Press the partition onto the body until the fingers click into place at the bottom of the case- see Figure 5.5. The channels have different sizes so the partition cannot be installed backwards.

5.4 Spur port connections

Each spur port connector provides (+), (-) and cable screen (S) connections. See section 5.5 for information on cable screen grounding.

Cable screen connections

The 'S' screen terminals for the trunk and the spurs are interconnected/commoned within the F3xx device and should be grounded at only *one point* for the whole segment (i.e. a single-point ground). The recommended position for that connection is in the control room close to the power supply at the DCS, or else in accordance with local system practice.

5.5 Surge protection

Each fieldbus terminal, trunk or spur, on a Megablock can be fitted with an FS32 surge protector to prevent damage to the internal components. The FS32 uses the same pluggable connector as the field connector; so the field connector is removed, the FS32 inserted and the original field connector is fitted to the FS32. See Figure 5.6 & 5.7.

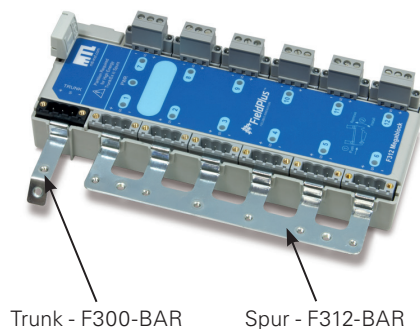

Figure 5.6: Typical grounding bars

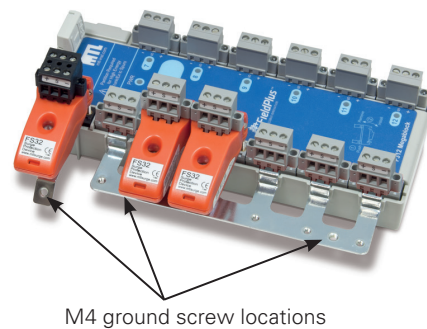

Figure 5.7: With some FS32 modules

Mounting brackets, known as “grounding bars;” can be fitted into ready moulded positions on both sides of the Megablock. (Grounding bar types are chosen to suit the model- see page 2.) The FS32 has a central mounting screw to provide a mechanical and electrical connection to the grounding bar. The bar must then be wired to a low-impedance, protective local ground point in order to dissipate any induced surge currents.

NOTE

If a trunk-spur partition is to be fitted (Section 5.3.1), install it **before** mounting the FS32 modules adjacent to it.

To mount FS32 surge protection modules on a Megablock:

1. Remove and retain the pluggable terminals from one side of the Megablock.
2. Locate the grounding bar lugs in the moulded positions on the side of the Megablock and press it firmly into place- see Figure 5.6.
3. Repeat 1 and 2 for the other side of the Megablock, if required.
4. Use an M4 screw and ring terminal to connect *each* grounding bar to a suitable low-impedance ground point- see Figure 5.7.
5. Mount an FS32 into one of the empty sockets and tighten its two plug screws, then tighten the grounding screw into the mounting bar.
6. Insert one of the pluggable terminals into the FS32 and tighten its securing screws.
7. Repeat 5 and 6 for all the other FS32 modules.

A separate grounding bar (F300-BAR) is used for the trunk connector, which must be similarly connected to ground- see Figures 5.6 & 5.7 Follow a similar procedure to the one above for the trunk circuit.

NOTE

The FS32 surge protector is not certified for installation in a Zone 2 hazardous area and should be used only in applications where the Megablock is installed in a safe (non-hazardous) area. Consult Eaton’s MTL product line for information on surge protection in Zone 2 hazardous areas.

6 TESTING

6.1 Power LED

Each Megablock has a green power LED (labelled PWR). This LED lights when the segment DC voltage exceeds 10V to indicate power is present.

6.2 Spur LEDs

A red LED is located next to each Megablock spur port. The LED lights when the SpurGuard™ current-limiting function is activated by a short-circuit on the spur.

7 ROUTINE MAINTENANCE

Check the general condition of the installation periodically to make sure that no deterioration has occurred. At least every two years (and more frequently for particularly harsh environments) check that:

- cable, wire connections, terminations, and screens are in good condition
- the green Power LED is lit
- no red spur LEDs are lit
- no signs of damage or corrosion are present



WARNING !

The plastic parts can store static charge. Clean only with a damp cloth to prevent static buildup.

8 ATEX SAFETY INSTRUCTIONS

The following information is in accordance with the Essential Health and Safety Requirements (Annex II) of the EU Directive 2014/34/EU [the ATEX Directive- safety of apparatus] and is provided for those locations where the ATEX Directive is applicable.

8.1 General

- a) This equipment must only be installed, operated and maintained by competent personnel. Such personnel shall have undergone training, which included instruction on the various types of protection and installation practices, the relevant rules and regulations, and on the general principles of area classification. Appropriate refresher training shall be given on a regular basis. [See clause 4.2 of EN 60079-17].
- b) This equipment has been designed to provide protection against all the relevant additional hazards referred to in Annex II of the directive, such as those in clause 1.2.7.
- c) This equipment has been designed to meet the requirements of EN 60079-15.

8.2 Installation

- a) The installation must comply with the appropriate European, national and local regulations, which may include reference to the code of practice EN 60079-14. In addition, particular industries or end users may have specific requirements relating to the safety of their installations and these requirements should also be met. For the majority of installations the Directive 1999/92/EC [the ATEX Directive- safety of installations] is also applicable.
- b) This apparatus may be installed in a safe area and also in a Zone 2 location providing that the relevant installation conditions are met. When mounted in a Zone 2 location the apparatus must be provided with an enclosure, which offers an additional degree of protection appropriate to the area classification.
- c) Unless already protected by design, this equipment must be protected by a suitable enclosure against:
 - i) mechanical and thermal stresses in excess of those noted in the certification documentation and the product specification
 - ii) aggressive substances, excessive dust, moisture and other contaminants.

Read also the Special Conditions for Safe Use (below) for any additional or more specific information.

Specific Conditions of Safe Use:

Ex nA IIC T4 Gc, Ex nA [ic] IIC T4 Gc, and Ex ec [ic] IIC T4 Gc

1. The apparatus is to be installed in an enclosure which maintains a minimum ingress protection rating of IP54 and meets the enclosure requirements of EN 60079-0, EN 60079-11, and EN 60079-15 as appropriate for the installation.
2. The apparatus shall only be used in an area of at least pollution degree 2, as defined by EN 60664-1.
3. Provisions shall be made externally to the apparatus to prevent the rated input being exceeded by transient disturbances of more than 140% of the rated voltage.

See footnote.

FISCO Ex ic IIC T4 Gc

1. The apparatus is to be installed in an enclosure which maintains a minimum ingress protection rating of IP54 and meets the enclosure requirements of EN 60079-0 and EN 60079-11.

NOTE: All MTL fieldbus power supplies are designed to protect the fieldbus trunk from transient disturbances on the DC power feed and will meet the requirements of maintaining transient disturbances below 140% of the rated voltage.

8.3 Inspection and maintenance

- a) Inspection and maintenance should be carried out in accordance with European, national and local regulations which may refer to the standard EN 60079-17. In addition specific industries or end users may have specific requirements which should also be met.
- b) Access to the internal circuitry must not be made during operation.

8.4 Repair

This product cannot be repaired by the user and must be replaced with an equivalent certified product.

8.5 Marking

Each device is marked in compliance with the Directive.

This information applies to products manufactured during or after the year 2011.

Typical certification marking

For F3xx

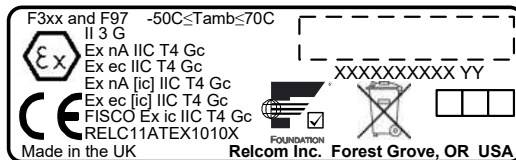

For F3xx-V2

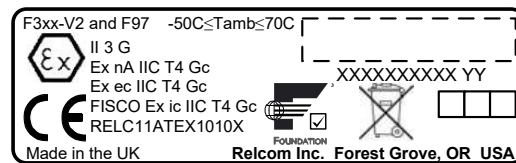

NOTE

For details of FM and IECEx approvals see Sections 9 & 10.

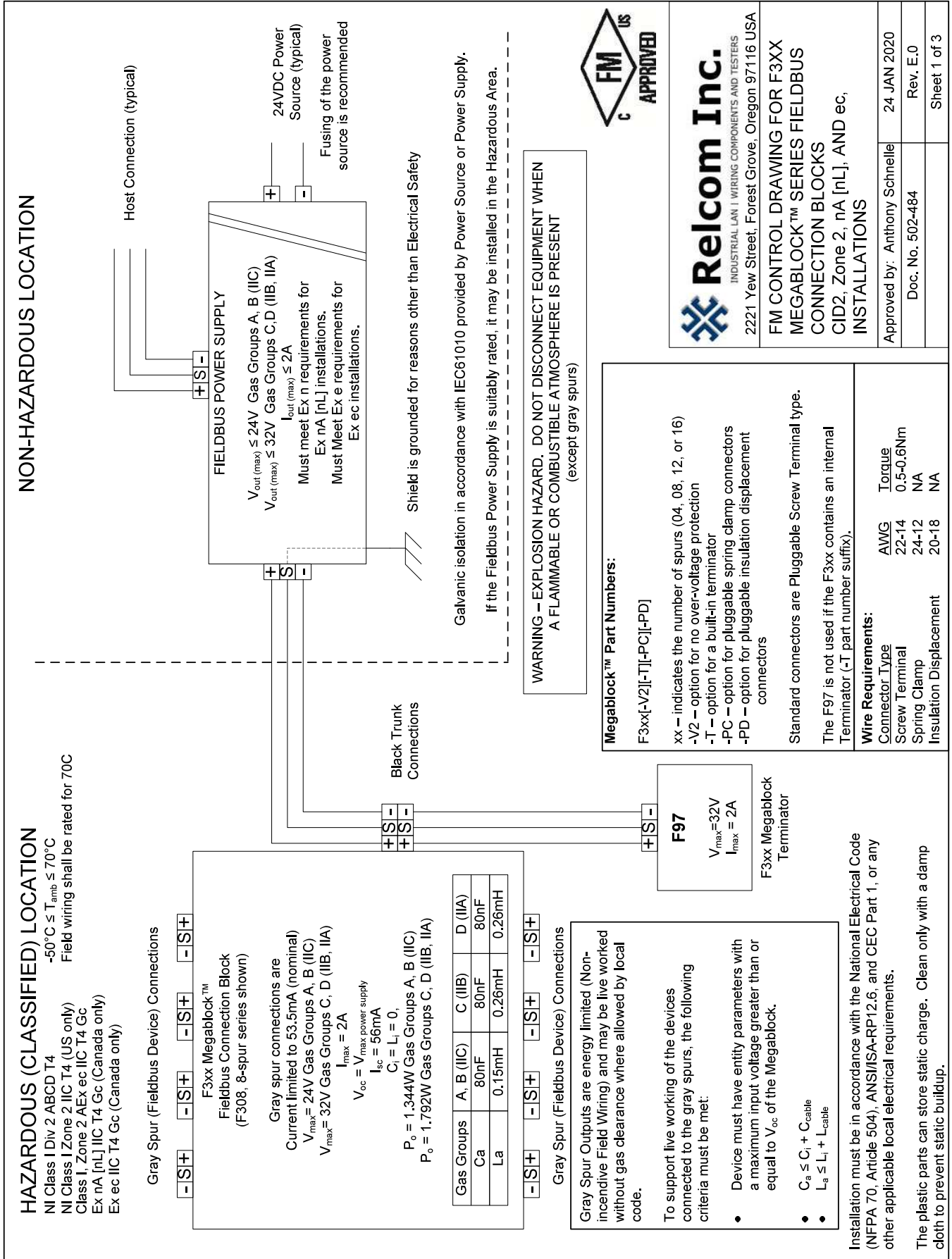

NON-HAZARDOUS LOCATION

HAZARDOUS (CLASSIFIED) LOCATION

NI Class I Div 2 ABCD T4
 -50°C ≤ T_{amb} ≤ 70°C
 Field wiring shall be rated for 70C
 NI Class I Zone 2 IIC T4 (US only)
 Class I, Zone 2 AEx ec IIC T4 Gc
 Ex nA [nL] IIC T4 Gc (Canada only)
 Ex ec IIC T4 Gc (Canada only)

Gray Spur (Fieldbus Device) Connections

F3xx Megablock™
 Fieldbus Connection Block
 (F308, 8-spur series shown)

Gray spur connections are
 Current limited to 53.5mA (nominal)
 V_{max} = 24V Gas Groups A, B (IIC)
 V_{max} = 32V Gas Groups C, D (IIB, IIA)
 I_{max} = 2A
 V_{oc} = V_{max power supply}
 I_{sc} = 56mA
 C_i = L_i = 0,
 P_o = 1,344W Gas Groups A, B (IIC)
 P_o = 1,792W Gas Groups C, D (IIB, IIA)

Gas Groups	A, B (IIC)	C (IIB)	D (IIA)
Ca	80nF	80nF	80nF
La	0.15mH	0.26mH	0.26mH

FIELDBUS POWER SUPPLY

V_{out (max)} ≤ 24V Gas Groups A, B (IIC)
 V_{out (max)} ≤ 32V Gas Groups C, D (IIB, IIA)
 I_{out (max)} ≤ 2A
 Must meet Ex n requirements for Ex nA [nL] installations.
 Must Meet Ex e requirements for Ex ec installations.

Shield is grounded for reasons other than Electrical Safety

Galvanic isolation in accordance with IEC61010 provided by Power Source or Power Supply.
 If the Fieldbus Power Supply is suitably rated, it may be installed in the Hazardous Area.

WARNING – EXPLOSION HAZARD. DO NOT DISCONNECT EQUIPMENT WHEN A FLAMMABLE OR COMBUSTIBLE ATMOSPHERE IS PRESENT (except gray spurs)

Gray Spur Outputs are energy limited (Non-incandive Field Wiring) and may be live worked without gas clearance where allowed by local code.

To support live working of the devices connected to the gray spurs, the following criteria must be met:

- Device must have entity parameters with a maximum input voltage greater than or equal to V_{oc} of the Megablock.
- C_a ≤ C_i + C_{cable}
- L_a ≤ L_i + L_{cable}

Megablock™ Part Numbers:
 F3xx[-V2][-T][-PC][-PD]

xx – indicates the number of spurs (04, 08, 12, or 16)
 -V2 – option for no over-voltage protection
 -T – option for a built-in terminator
 -PC – option for pluggable spring clamp connectors
 -PD – option for pluggable insulation displacement connectors

Standard connectors are Pluggable Screw Terminal type.

The F97 is not used if the F3xx contains an internal Terminator (-T part number suffix).

Wire Requirements:

Connector Type	AWG	Torque
Screw Terminal	22-14	0.5-0.6Nm
Spring Clamp	24-12	NA
Insulation Displacement	20-18	NA

F97
 V_{max} = 32V
 I_{max} = 2A
 F3xx Megablock Terminator

Installation must be in accordance with the National Electrical Code (NFPA 70, Article 504), ANSI/ISA-RP12.6, and CEC Part 1, or any other applicable local electrical requirements.

The plastic parts can store static charge. Clean only with a damp cloth to prevent static buildup.



Relcom Inc.
 INDUSTRIAL LAN | WIRING COMPONENTS AND TESTERS
 2221 Yew Street, Forest Grove, Oregon 97116 USA

FM CONTROL DRAWING FOR F3XX MEGABLOCK™ SERIES FIELDBUS CONNECTION BLOCKS CID2, Zone 2, nA [nL], AND ec, INSTALLATIONS

Approved by: Anthony Schnelle 24 JAN 2020
 Doc. No. 502-484 Rev. E.0
 Sheet 1 of 3

HAZARDOUS (CLASSIFIED) LOCATION

Class I, Zone 2 AEx ec [ic] IIC T4 Gc -50°C ≤ T_{amb} ≤ 70°C
 Ex ec [ic] IIC, T4 Gc (Canada only) Field wiring shall be rated for 70C

Gray Spur (Fieldbus Device) Connections



F3xx Megablock™
 Fieldbus Connection Block
 (F308, 8-spur series shown)

Gray spur connections are
 Current limited to 53.5mA (nominal)
 $V_{max} = 24V$ Gas Groups A, B (IIC)
 $V_{max} = 32V$ Gas Groups C, D (IIB, IIA)
 $I_{max} = 2A$

$V_{oc} = V_{max}$ power supply
 $I_{sc} = 56mA$
 $C_i = L_i = 0$

$P_o = 1.344W$ Gas Groups A, B (IIC)
 $P_o = 1.792W$ Gas Groups C, D (IIB, IIA)

Gas Groups	A, B (IIC)	C (IIB)	D (IIA)
Ca	80nF	80nF	80nF
La	0.15mH	0.26mH	0.26mH

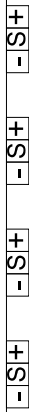

Gray Spur (Fieldbus Device) Connections

Gray Spur Outputs are energy limited (Non-incendiive Field Wiring) and may be live worked without gas clearance where allowed by local code.

To support live working of the devices connected to the gray spurs, the following criteria must be met:

- Device must have entity parameters with a maximum input voltage greater than or equal to V_{oc} of the Megablock.
- $C_a \leq C_i + C_{cable}$
- $L_a \leq L_i + L_{cable}$

Installation must be in accordance with the National Electrical Code (NFPA 70, Article 504), ANSI/ISA-RP12.6, and CEC Part 1, or any other applicable local electrical requirements.

The plastic parts can store static charge. Clean only with a damp cloth to prevent static buildup.

F97
 $V_{max} = 32V$
 $I_{max} = 2A$

F3xx Megablock Terminator

Standard connectors are Pluggable Screw Terminal type.

The F97 is not used if the F3xx contains an internal Terminator (-T part number suffix).

Wire Requirements:

Connector Type	AWG	Torque
Screw Terminal	22-14	0.5-0.6Nm
Spring Clamp	24-12	NA
Insulation Displacement	20-18	NA

NON-HAZARDOUS LOCATION

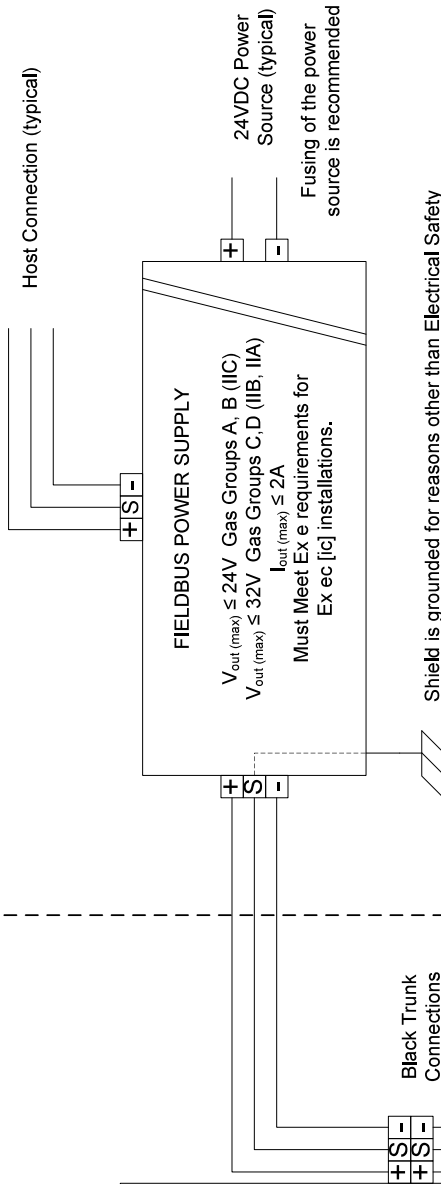

Galvanic isolation in accordance with IEC61010 provided by Power Source or Power Supply.
 If the Fieldbus Power Supply is suitably rated, it may be installed in the Hazardous Area.

WARNING – EXPLOSION HAZARD. DO NOT DISCONNECT EQUIPMENT WHEN A FLAMMABLE OR COMBUSTIBLE ATMOSPHERE IS PRESENT
 (except gray spurs)



INDUSTRIAL LAN | WIRING COMPONENTS AND TESTERS
 2221 Yew Street, Forest Grove, Oregon 97116 USA

FM CONTROL DRAWING FOR F3XX
 MEGABLOCK™ SERIES FIELDBUS
 CONNECTION BLOCKS
 Ec [ic] INSTALLATIONS

Approved by: Anthony Schnelle	Date: 24 JAN 2020
Doc. No. 502-484	Rev. E.0
	Sheet 2 of 3

Installing the Partition, Terminator, and Connector

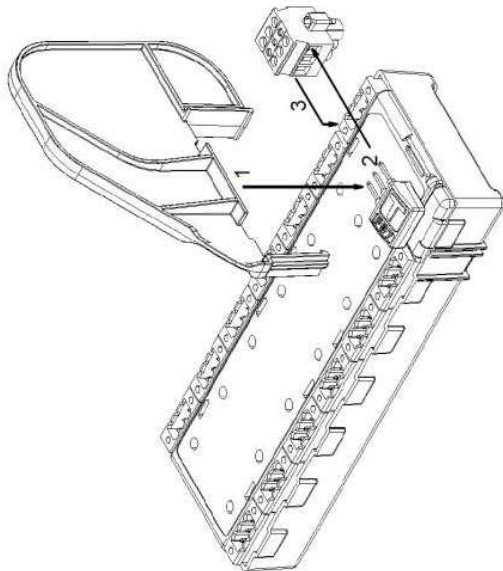

Partition, Terminator, and Connector Installed

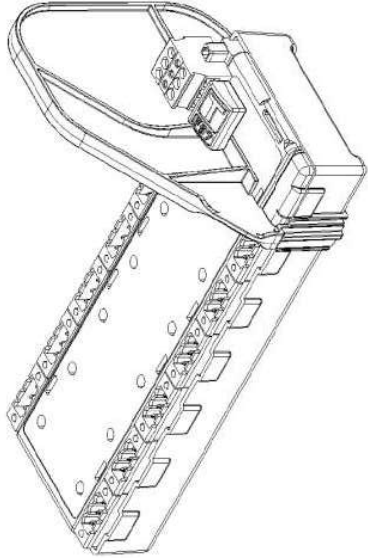

Partition Installation

The Partition must be installed for Ex nA [ic] applications. Orient the partition as shown above and press down as indicated by the arrow. The 'fingers' will slide in the two channels on each side of the F3xx until they latch in place at the bottom of the case. The channels are sized differently so the Partition cannot be installed backwards.

Terminator Installation

If needed the F97 Terminator is installed in the Black Dual Pluggable connector as shown above. Insert it into the connector and tighten the screws.

Connector Installation

The connectors are installed as shown in the diagram above. Fully insert them into the mating connector on the F3xx. Secure the two retaining screws to prevent the connector from unexpectedly dislodging.

DIN Rail Mounting

F3xx Megablocks are designed to be mounted on 35 mm DIN rail using the clip mechanism on the back of each unit. Mounting can be vertical or horizontal. Use of DIN rail end stops is recommended.

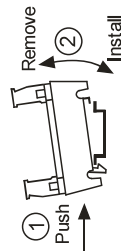

Repair and Maintenance

No regular maintenance is required for these products. There are also no user serviceable parts in this product. Contact the distributor or factory for any product issues.

Specific Conditions of Use

- The apparatus shall be installed within a tool-secured enclosure which meets a minimum ingress protection rating of IP54 in accordance with ANSI/ISA/CSA C22.2 No. 60079-0 and ANSI/ISA/CSA C22.2 No. 60079-15 as applicable.
- The apparatus shall be installed in an enclosure meeting the requirements of ANSI/ISA 61010-1 (82,02,01) and CSA Standard C22.2 No 61010-1.
- The apparatus shall be installed in compliance with the enclosure, mounting, spacing and segregation requirements of the ultimate application.
- Provisions shall be made externally to the F3XX to prevent the rated input being exceeded by transient disturbances of more than 140% of the rated voltage.
- The apparatus shall only be used in an area of at least pollution degree 2, as defined in IEC 60664-1.

Certification Markings F3xx



 NI Class I Div 2 ABCD T4

 NI Class I Zone 2 IIC T4 (US only)

 Class I, Zone 2 A, Ex ec [ic] IIC T4 Gc

 Ex nA [nL] IIC T4 Gc (Canada only)

 Ex ec [nL] IIC T4 Gc (Canada only)

 FM17US0075X Install per document 502-484

 Relcom Inc., Forest Grove, OR USA

Certification Markings – F3xx-V2



 NI Class I Div 2 ABCD T4

 NI Class I Zone 2 IIC T4 (US only)

 Class I, Zone 2 A, Ex ec IIC T4 Gc

 Ex nA [nL] IIC T4 Gc (Canada only)

 Ex ec [nL] IIC T4 Gc (Canada only)

 FM17CA0041X

 Ex ec IIC T4 Gc (Canada only)

 FM17US0075X Install per document 502-484

 Relcom Inc., Forest Grove, OR USA



INDUSTRIAL LAN | WIRING COMPONENTS AND TESTERS
2221 Yew Street, Forest Grove, Oregon 97116 USA

F3XX MEGABLOCK™ SERIES

INSTALLATION INSTRUCTIONS

Approved by: Anthony Schnelle Date: 24 JAN 2020

Doc. No. 502-484

Rev. E.0

Sheet 3 of 3

10 IECEX SAFETY INSTRUCTIONS

10.1 SPECIFIC CONDITIONS OF USE

Ex nA IIC T4 Gc, Ex ec IIC T4 Gc, Ex nA [ic] IIC T4 Gc and Ex ec [ic] IIC T4 Gc:

1. The apparatus is to be installed within an enclosure which maintains a minimum ingress protection rating of IP54 in accordance with IEC 60079-0 and IEC 60079-15 as applicable.
2. Provisions shall be made externally to the apparatus to prevent the rated input being exceeded by transient disturbances of more than 140% of the rated voltage.
3. The apparatus shall only be installed in an area of at least pollution degree 2, as defined in IEC 60664-1.

See footnote.

Ex ic IIC T4 Gc FISCO

1. The apparatus is to be installed in an enclosure which maintains a minimum ingress protection rating of IP54 and meets the enclosure requirements of IEC 60079-0 and IEC 60079-11.

Note: All MTL fieldbus power supplies are designed to protect the fieldbus trunk from transient disturbances on the DC power feed and will meet the requirements of maintaining transient disturbances below 140% of the rated voltage.

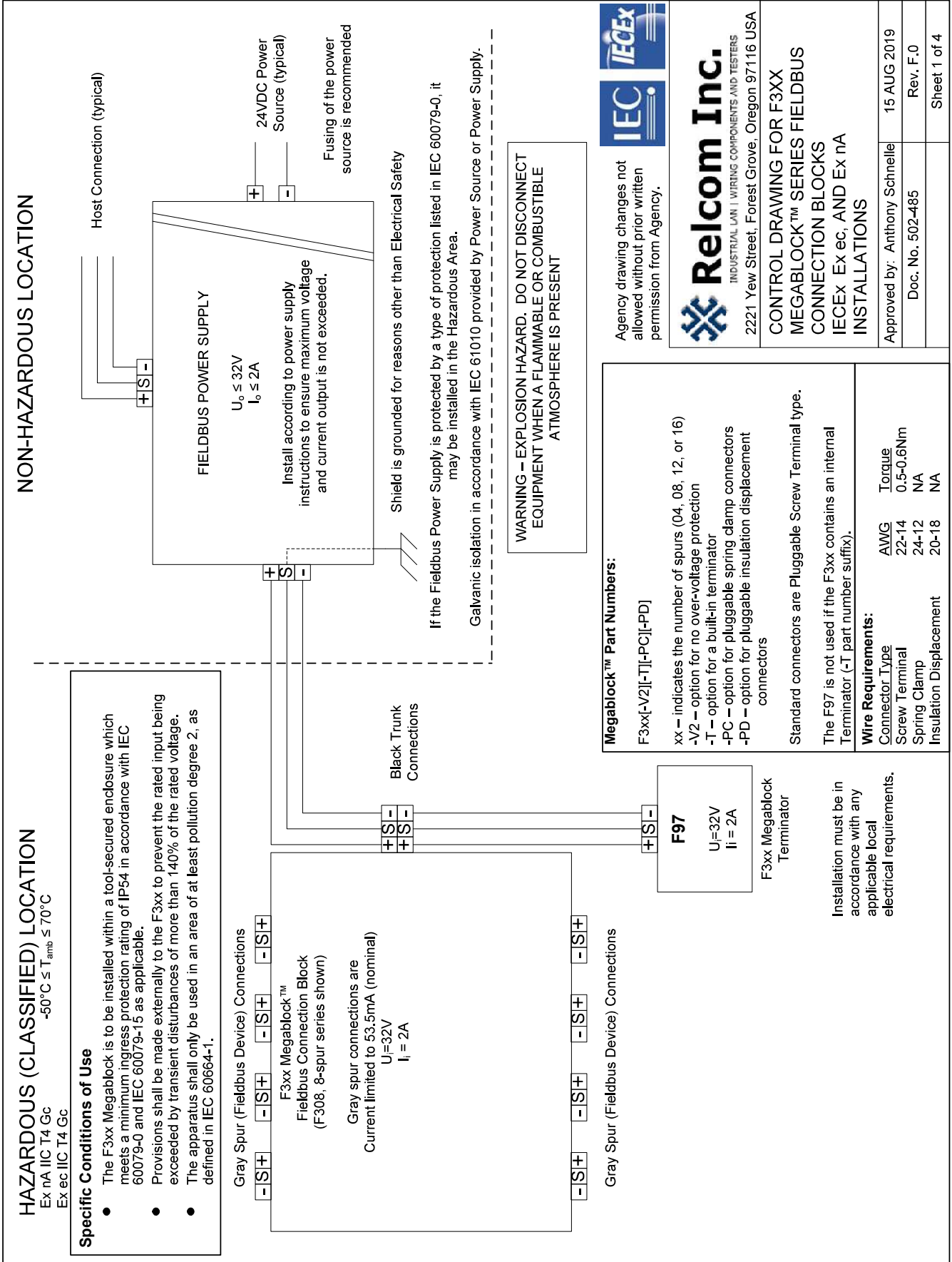

NON-HAZARDOUS LOCATION

HAZARDOUS (CLASSIFIED) LOCATION
 Ex nA IIC T4 Gc
 -50°C ≤ T_{amb} ≤ 70°C
 Ex ec IIC T4 Gc

Specific Conditions of Use

- The F3xx Megablock is to be installed within a tool-secured enclosure which meets a minimum ingress protection rating of IP54 in accordance with IEC 60079-0 and IEC 60079-15 as applicable.
- Provisions shall be made externally to the F3xx to prevent the rated input being exceeded by transient disturbances of more than 140% of the rated voltage.
- The apparatus shall only be used in an area of at least pollution degree 2, as defined in IEC 60664-1.

Gray Spur (Fieldbus Device) Connections

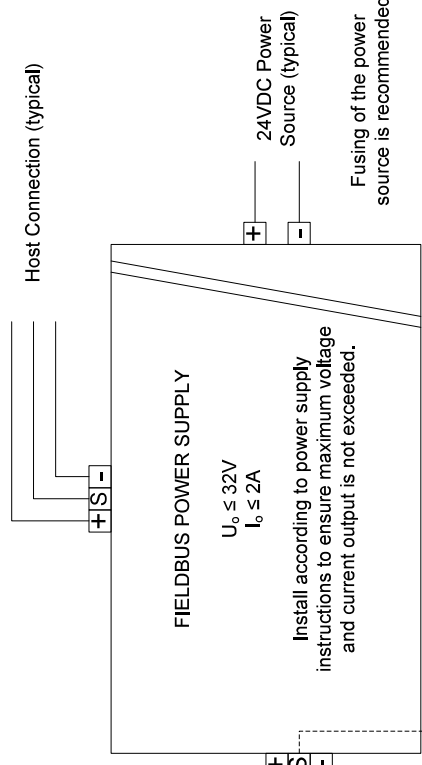
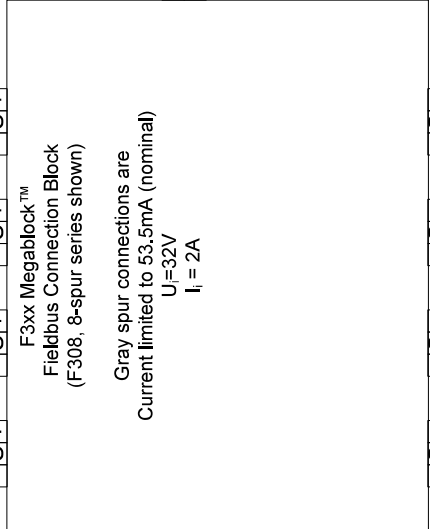

WARNING - EXPLOSION HAZARD. DO NOT DISCONNECT EQUIPMENT WHEN A FLAMMABLE OR COMBUSTIBLE ATMOSPHERE IS PRESENT

Megablock™ Part Numbers:

F3xx[-V2][-T][-PC][-PD]

xx – indicates the number of spurs (04, 08, 12, or 16)
 -V2 – option for no over-voltage protection
 -T – option for a built-in terminator
 -PC – option for pluggable spring clamp connectors
 -PD – option for pluggable insulation displacement connectors

Standard connectors are Pluggable Screw Terminal type.

The F97 is not used if the F3xx contains an internal Terminator (-T part number suffix).

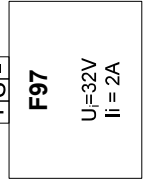

Installation must be in accordance with any applicable local electrical requirements.

Wire Requirements:

Connector Type	AWG	Torque
Screw Terminal	22-14	0.5-0.6Nm
Spring Clamp	24-12	NA
Insulation Displacement	20-18	NA

Agency drawing changes not allowed without prior written permission from Agency.

IEC IECEx

Relcom Inc.
 INDUSTRIAL LAM | WIRING COMPONENTS AND TESTERS
 2221 Yew Street, Forest Grove, Oregon 97116 USA

CONTROL DRAWING FOR F3XX MEGABLOCK™ SERIES FIELDBUS CONNECTION BLOCKS IECEx Ex ec, AND Ex nA INSTALLATIONS

Approved by: Anthony Schnelle 15 AUG 2019
 Doc. No. 502-485 Rev. F.0
 Sheet 1 of 4

HAZARDOUS (CLASSIFIED) LOCATION

Ex nA [ic] IIC T4 Gc
-50°C ≤ T_{amb} ≤ 70°C
Ex ec [ic] IIC T4 Gc

Specific Conditions of Use

- The F3xx Megablock is to be installed within a tool-secured enclosure which meets a minimum ingress protection rating of IP54 in accordance with IEC 60079-0 and IEC 60079-15 as applicable.
- Provisions shall be made externally to the F3xx to prevent the rated input being exceeded by transient disturbances of more than 140% of the rated voltage.
- The apparatus shall only be used in an area of at least pollution degree 2, as defined in IEC 60664-1.

Gray Spur (Fieldbus Device) Connections



Gray spur connections are
Current limited to 53.5mA (nominal)

U_i = 24V (IIC), U_i = 32V (IIB, IIA)
I_i = 2A, C_i = 0, L_i = 0

U_o = Megablock input voltage. The apparatus
supplying the input voltage must provide voltage
limiting meeting IEC 60079-11 requirements.

I_o = 56mA

P_o = 1.344W (IIC), P_o = 1.792W (IIB, IIA)

Gas Groups	IIC	IIB	IIA
C _o	80nF	80nF	80nF
L _o	0.15mH	0.26mH	0.26mH

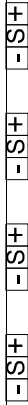

Gray Spur (Fieldbus Device) Connections

Ex ic (FISCO) Gray Spur Outputs:

- Cable ≤ 60m
- Cable Resistance R_c: 15-150ohms/km
- Cable Capacitance C_c: 45-200nF/km
- Cable Inductance L_c: 0.4-1.0mH/km
- Fieldbus device FISCO certified in accordance with IEC 60079-27.
- U_o of Fieldbus Power Supply ≤ 17.5V
- Installation to comply with IEC 60079-27.

Ex ic (Entity) Gray Spur Outputs:

- C_o > C_i + C_{able}
- L_o > L_i + L_{able}
- Fieldbus device 'Ex i' rated to meet U_o of Megablock and have entity parameters.

NON-HAZARDOUS LOCATION

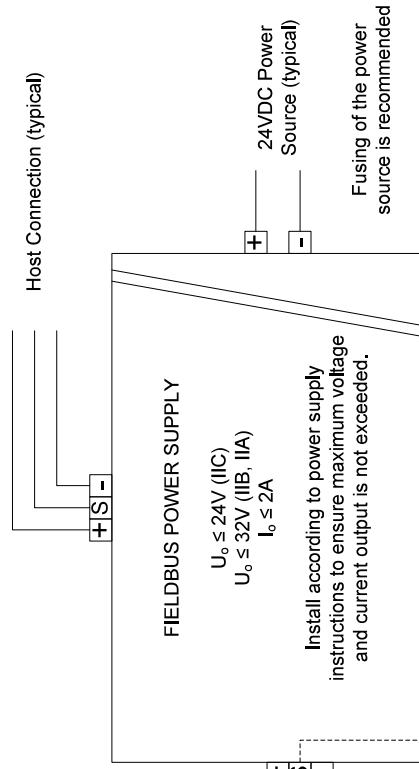

Fusing of the power
source is recommended

Shield is grounded for reasons other than Electrical Safety

If the Fieldbus Power Supply is protected by a type of protection listed in IEC 60079-0, it
may be installed in the Hazardous Area.

Galvanic isolation in accordance with IEC 61010 provided by Power Source or Power Supply.

SEPARATOR MUST BE
INSTALLED BETWEEN BLACK
AND GRAY CONNECTORS TO
SUPPORT [ic] RATING

WARNING – EXPLOSION HAZARD. DO NOT DISCONNECT
EQUIPMENT WHEN A FLAMMABLE OR COMBUSTIBLE
ATMOSPHERE IS PRESENT
(except gray spurs).

Megablock™ Part Numbers:

F3xx(-T)|(-PC)|(-PD)

xx – indicates the number of spurs (04, 08, 12, or 16)

-T – option for a built-in terminator

-PC – option for pluggable spring clamp connectors

-PD – option for pluggable insulation displacement
connectors

Standard connectors are Pluggable Screw Terminal type.

The F97 is not used if the F3xx contains an internal
Terminator (-T part number suffix).

Wire Requirements:

Connector Type	AWG	Torque
Screw Terminal	22-14	0.5-0.6Nm
Spring Clamp	24-12	NA
Insulation Displacement	20-18	NA

Agency drawing changes not
allowed without prior written
permission from Agency.



INDUSTRIAL LAN | WIRING COMPONENTS AND TESTERS

2221 Yew Street, Forest Grove, Oregon 97116 USA

CONTROL DRAWING FOR F3XX
MEGABLOCK™ SERIES FIELDBUS
CONNECTION BLOCKS
IECEX Ex ec [ic], AND Ex nA [ic]
INSTALLATIONS

Approved by: Anthony Schnelle

15 AUG 2019

Doc. No. 502-485

Rev. F.0

Sheet 2 of 4

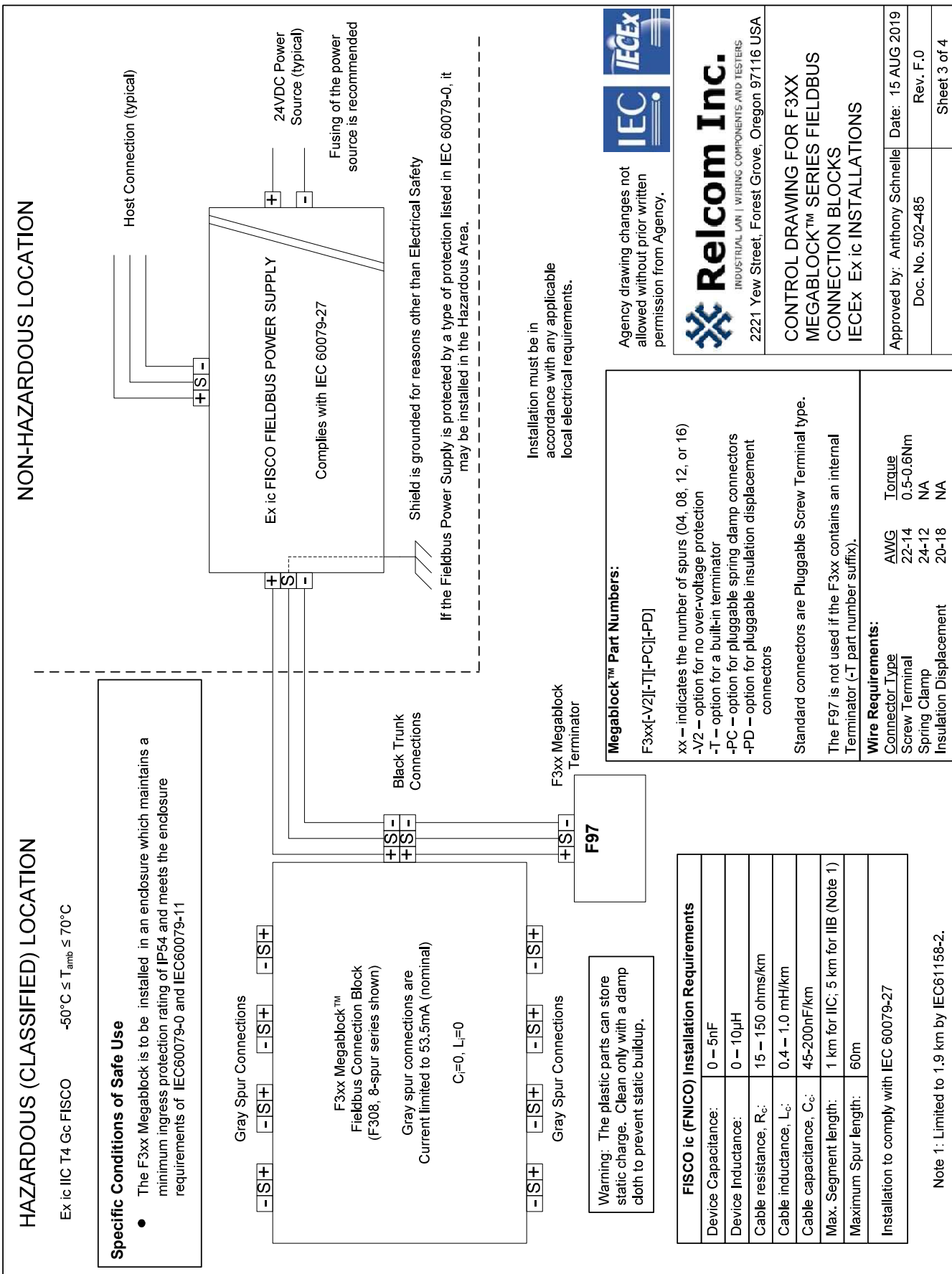

Specific Conditions of Safe Use

- The F3xx Megablock is to be installed in an enclosure which maintains a minimum ingress protection rating of IP54 and meets the enclosure requirements of IEC60079-0 and IEC60079-11

Warning: The plastic parts can store static charge. Clean only with a damp cloth to prevent static buildup.

FISCO ic (FNICO) Installation Requirements	
Device Capacitance:	0 – 5nF
Device Inductance:	0 – 10µH
Cable resistance, R _c :	15 – 150 ohms/km
Cable inductance, L _c :	0.4 – 1.0 mH/km
Cable capacitance, C _c :	45-200nF/km
Max. Segment length:	1 km for IIC; 5 km for IIB (Note 1)
Maximum Spur length:	60m
Installation to comply with IEC 60079-27	

Megablock™ Part Numbers:
 F3xx[-V2][-T][-PC][-PD]

xx – indicates the number of spurs (04, 08, 12, or 16)
 -V2 – option for no over-voltage protection
 -T – option for a built-in terminator
 -PC – option for pluggable spring clamp connectors
 -PD – option for pluggable insulation displacement connectors

Standard connectors are Pluggable Screw Terminal type.
 The F97 is not used if the F3xx contains an internal Terminator (-T part number suffix).

Wire Requirements:

Connector Type	AWG	Torque
Screw Terminal	22-14	0.5-0.6Nm
Spring Clamp	24-12	NA
Insulation Displacement	20-18	NA

Note 1: Limited to 1.9 km by IEC61158-2.

Installation must be in accordance with any applicable local electrical requirements.

Agency drawing changes not allowed without prior written permission from Agency.



Relcom Inc.
 INDUSTRIAL LAW | WIRING COMPONENTS AND TESTERS
 2221 Yew Street, Forest Grove, Oregon 97116 USA

CONTROL DRAWING FOR F3XX MEGABLOCK™ SERIES FIELDBUS CONNECTION BLOCKS IECEx Ex ic INSTALLATIONS

Approved by: Anthony Schnelle	Date: 15 AUG 2019
Doc. No. 502-485	Rev. F.0
	Sheet 3 of 4

Installing the Partition, Terminator, and Connector

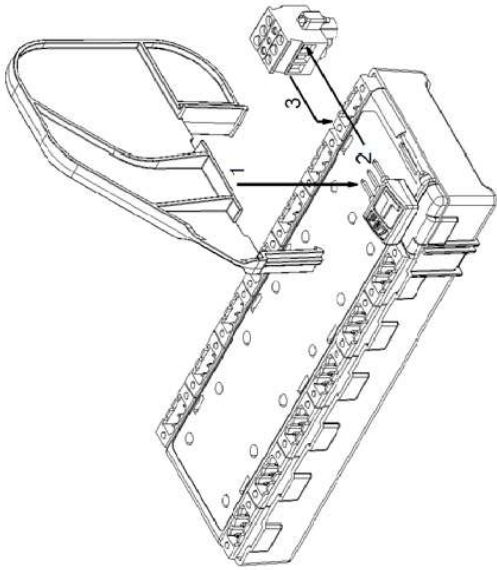

Partition, Terminator, and Connector Installed

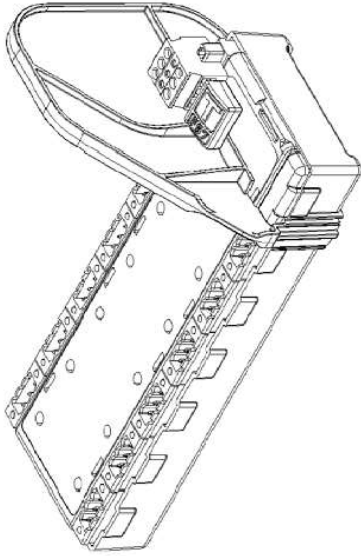

Partition Installation

The Partition must be installed for Ex nA [ic] and EX ec [ic] applications. Orient the partition as shown above and press down as indicated by the arrow. The 'fingers' will slide in the two channels on each side of the F3xx until they latch in place at the bottom of the case. The channels are sized differently so the Partition cannot be installed backwards.

Terminator Installation

If needed the F97 Terminator is installed in the Black Dual Pluggable connector as shown above. Insert it into the connector and tighten the screws.

Connector Installation

The connectors are installed as shown in the diagram above. Fully insert them into the mating connector on the F3xx. Secure the two retaining screws to prevent the connector from unexpectedly dislodging.

DIN Rail Mounting

F3xx Megablocks are designed to be mounted on 35 mm DIN rail using the clip mechanism on the back of each unit. Mounting can be vertical or horizontal. Use of DIN rail end stops is recommended.

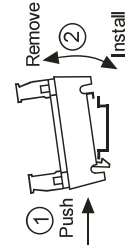

Certification Markings – F3xx

F3xx and F97 IECEx FMG 11.0017 X
 Install per Doc. No. 502-485
 Ex nA IIC T4 Gc Ex ec IIC T4 Gc
 Ex nA [ic] IIC T4 Gc Ex ec [ic] IIC T4 Gc
 Ex ic IIC T4 Gc FISCO
 -50C-Tamb<70C

Certification Markings – F3xx-V2

F3xx-V2 and F97 IECEx FMG 11.0017 X
 Install per Doc. No. 502-485
 Ex nA IIC T4 Gc Ex ec IIC T4 Gc
 Ex ic IIC T4 Gc FISCO
 -50C-Tamb<70C

Repair and Maintenance

No maintenance is required for these products. There are also no user serviceable parts in these products. Contact the distributor or factory for any product issues.



Agency drawing changes not allowed without prior written permission from Agency.



INDUSTRIAL LAN | WIRING COMPONENTS AND TESTERS
 2221 Yew Street, Forest Grove, Oregon 97116 USA

F3XX MEGABLOCK™ SERIES

INSTALLATION INSTRUCTIONS

Approved by: Anthony Schnelle 15 AUG 2019

Doc. No. 502-485 Rev. F.0

Sheet 4 of 4

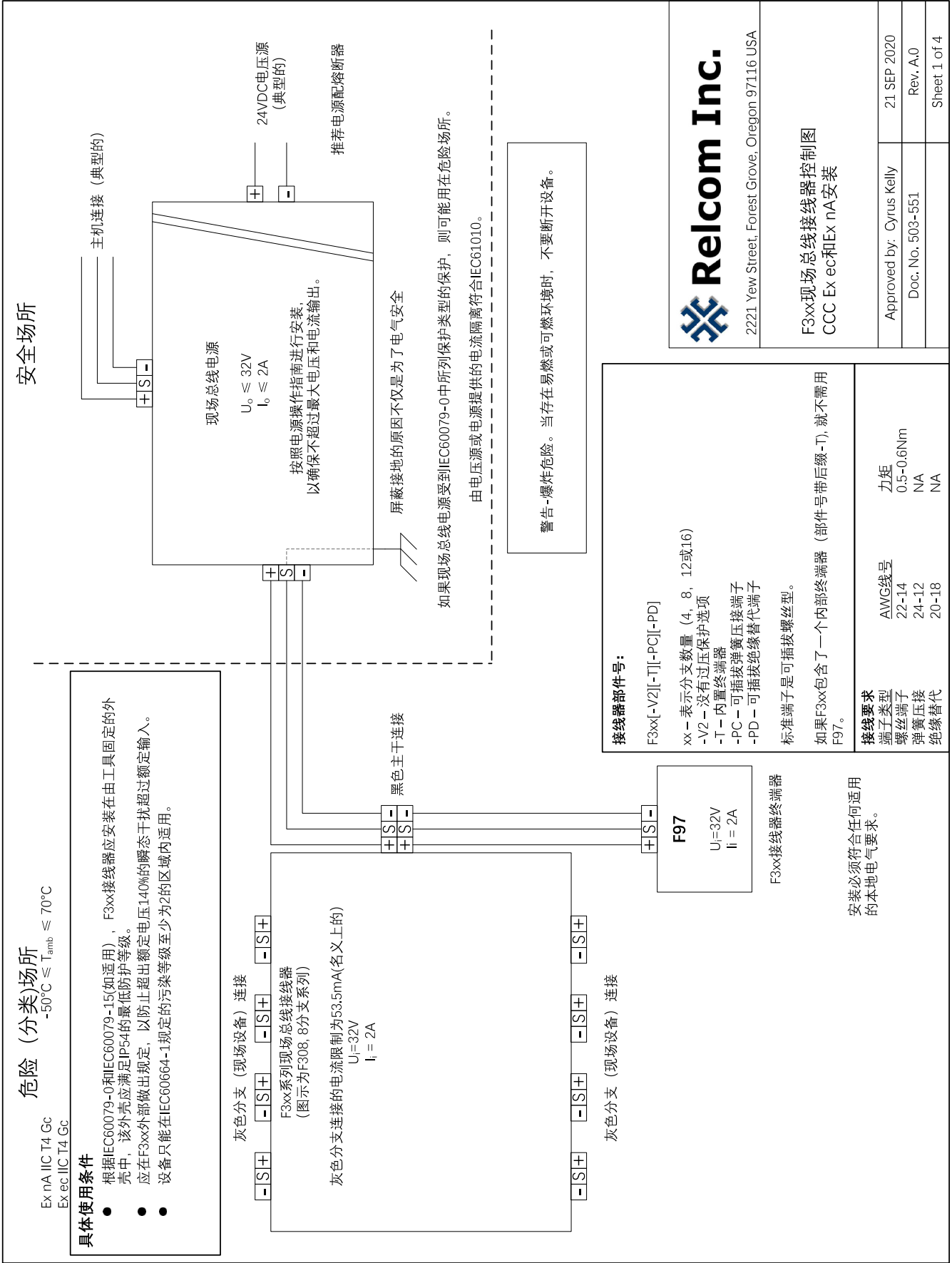

危险 (分类)场所

Ex nA [ic] IIC T4 Gc
 -50°C ≤ T_{amb} ≤ 70°C
 Ex ec [ic] IIC T4 Gc

具体使用条件

- 根据IEC60079-0和IEC60079-15(如适用), F3xx接线器应安装在由工具固定的外壳中, 该外壳应满足IP54的最低防护等级。
- 应在F3xx外部做出规定, 以防止超出额定电压140%的瞬态干扰超过额定输入。
- 设备只能在IEC60664-1规定的污染等级至少为2的区域内适用。

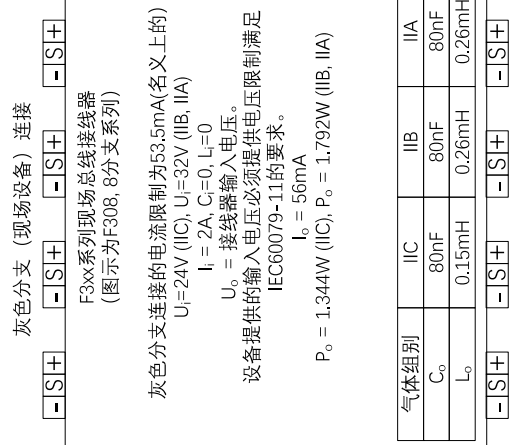

- Ex ic(FISCO)灰色端子输出:
- 电缆长度 ≤ 60m
 - 电缆阻抗R_c: 15-150ohms/km
 - 电缆电容C_c: 45-200nF/km
 - 电缆电感L_c: 0.4-1.0mH/km
 - 现场总线设备FISCO认证符合IEC60079-27.
 - 现场总线电源U_o ≤ 17.5V
 - 安装符合IEC60079-27.
- Ex ic(Entity)灰色端子输出:
- C_o > C_i + C_{cable}
 - L_o > L_i + L_{cable}
 - 现场总线设备Ex i 额定值满足接线器的U_o, 并具有实体参数。

安装必须符合任何适用的本地电气要求。

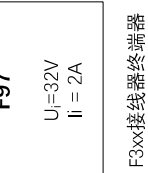

接线器部件号:

F3xx[-T][-PC][-PD]

- xx - 表示分支数量 (4, 8, 12或16)
 - T - 内置终端器
 - PC - 可插拔弹簧压接端子
 - PD - 可插拔绝缘替代端子
- 标准端子是可插拔螺线型。

如果F3xx包含了一个内部终端器 (部件号带后缀-T), 就不需用F97。

接线要求
 端子类型
 螺线型
 弹簧压接
 绝缘替代

力矩
 0.5-0.6Nm
 NA
 NA

安全场所

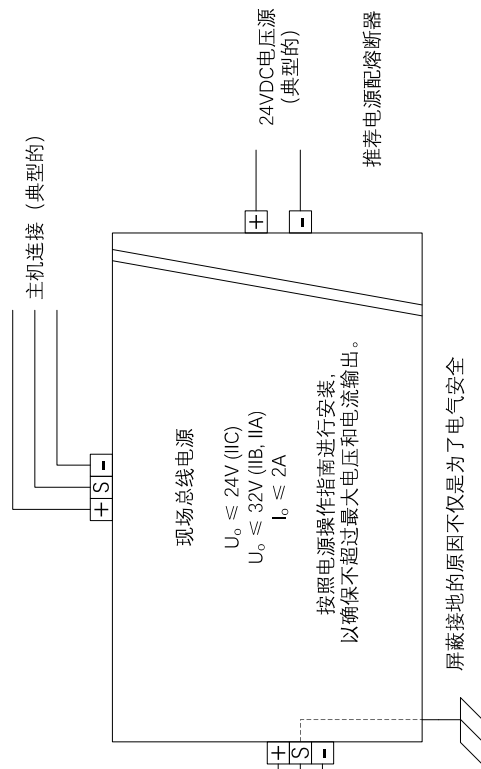

如果现场总线电源受到IEC60079-0中所列保护类型的保护, 则可能用在危险场所。
 由电压源或电源提供的电流隔离符合IEC61010。

黑色和灰色端子之间必须安装隔板以支持[ic]等级。

警告 - 爆炸危险。当存在易燃或可燃环境时, 不要断开设备。
 (灰色端子除外)



2221 Yew Street, Forest Grove, Oregon 97116 USA

F3xx现场总线接线器控制图
 CCC Ex ec [ic] 和 Ex nA [ic] 安装

Approved by: Cyrus Kelly
 Doc. No. 503-551

21 SEP 2020
 Rev. A.0
 Sheet 2 of 4

危险 (分类)场所

Ex ic IIC T4 Gc FISCO field device $-50^{\circ}\text{C} \leq T_{amb} \leq 70^{\circ}\text{C}$

具体使用条件:

- F3xx接线器安装在外壳内, 外壳的最低防护等级为IP54, 并满足IEC60079-0和IEC60079-11的外壳要求。

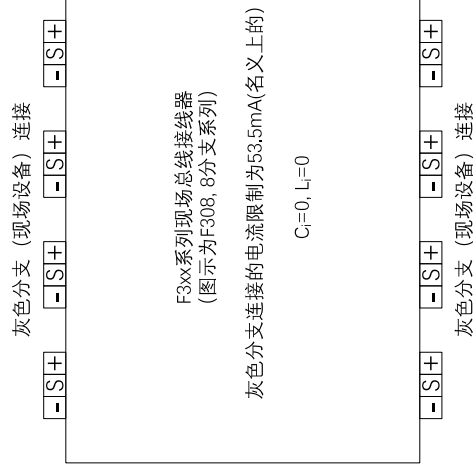

警告: 塑料部件可储存静电。仅可用湿布清洁, 以防止静电堆积。

FISCO ic (FNICO) Installation Requirements	
设备电容	0 - 5nF
设备电感	0 - 10µH
电缆电阻, R _c	15 - 150 ohms/km
电缆电感, L _c	0.4 - 1.0 mH/km
电缆电容, C _c	45-200nF/km
最大网段长度:	IIC 1km, IIB 5km(注1)
最大分支长度	60m
安装符合IEC60079-27.	

注1: IEC61158-2限制为1.9km.

安全场所

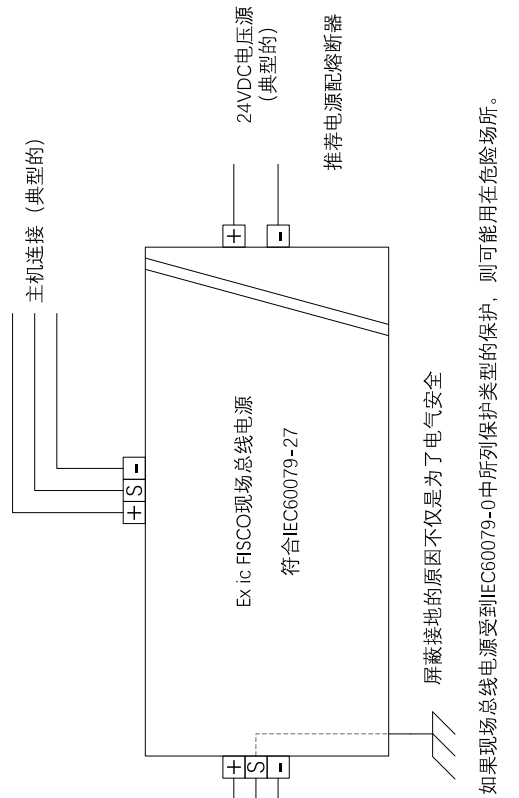

如果现场总线电源受到IEC60079-0中所列保护类型的保护, 则可能用在危险场所。

安装必须符合任何适用的本地电气要求。

接线器部件号:

F3xx[-V2][-T][-PC][-PD]

- xx - 表示分支数量 (4, 8, 12或16)
 - V2 - 没有过压保护
 - T - 内置终端器
 - PC - 可插拔弹簧压接端子
 - PD - 可插拔绝缘替代端子
- 标准端子是可插拔螺丝型。

如果F3xx包含了一个内部终端器 (部件号带后缀-T), 就不需用F97。

接线要求

端子类型	AWG线号	力矩
螺线端子	22-14	0.5-0.6Nm
弹簧压接	24-12	NA
绝缘替代	20-18	NA



2221 Yew Street, Forest Grove, Oregon 97116 USA

F3xx现场总线接线器控制图
CCC Ex ic 安装

Approved by: Cyrus Kelly	21 SEP 2020
Doc. No. 503-551	Rev. A.0
	Sheet 3 of 4

安装隔板，终端器和端子

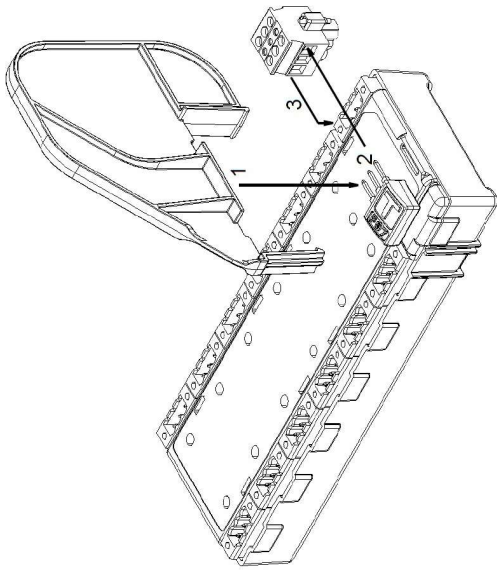

已安装的隔板，终端器和端子

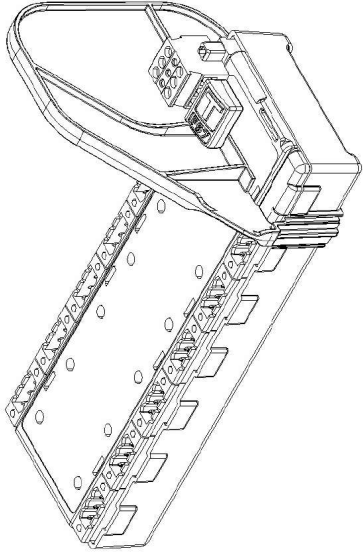

隔板安装

必须为Ex nA[Ic]和Ex ec[Ic]应用安装隔板。如上图所示调整隔板方向，并按箭头所示向下接。“手指”将在F3xx每侧的两个通道中滑动，直到它们在外壳底部锁定到位。通道的大小不同，因此隔板不能反向安装。

终端器安装

如有需要，F97终端器安装在上图所示的黑色双排可插拔端子上。将其插入端子并拧紧螺钉。

端子安装

端子的安装如上图所示。将它们完全插入F93xx上的配对接头。固定两个固定螺钉，以防止端子意外脱落。

DIN 导轨安装

F3xx接线器设计为使用每个模块背面的夹持机构安装在35mm DIN导轨上。可以垂直或水平安装。建议使用DIN导轨端部挡块。

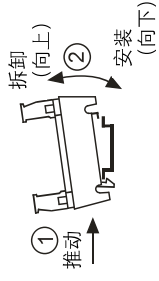

维修和维护

这些产品不需要维护。这些产品中也没有用户可维修的部件。若有任何产品问题请联系经销商或工厂。



2221 Yew Street, Forest Grove, Oregon 97116 USA

F3xx接线器安装指南

Approved by: Cyrus Kelly

21 SEP 2020

Doc. No. 503-551

Rev. A.0

Sheet 4 of 4

THIS PAGE IS LEFT INTENTIONALLY BLANK

AUSTRALIA

Eaton Electrical (Australia) Pty Ltd,
10 Kent Road, Mascot, New South Wales, 2020, Australia
Tel: +61 1300 308 374 Fax: +61 1300 308 463
E-mail: mtl-salesanz@eaton.com

BeNeLux

MTL Instruments BV
Ambacht 6, 5301 KW Zaltbommel
The Netherlands
Tel: +31 (0) 418 570290 Fax: +31 (0) 418 541044
E-mail: mtl.benelux@eaton.com

CHINA

Cooper Electric (Shanghai) Co. Ltd
955 Shengli Road, Heqing Industrial Park
Pudong New Area, Shanghai 201201
Tel: +86 21 2899 3817 Fax: +86 21 2899 3992
E-mail: mtl-cn@eaton.com

FRANCE

MTL Instruments srl,
7 rue des Rosieristes, 69410 Champagne au Mont d'Or
France
Tel: +33 (0)4 37 46 16 53 Fax: +33 (0)4 37 46 17 20
E-mail: mtlfrance@eaton.com

GERMANY

MTL Instruments GmbH,
Heinrich-Hertz-Str. 12, 50170 Kerpen, Germany
Tel: +49 (0)22 73 98 12-0 Fax: +49 (0)22 73 98 12-2 00
E-mail: csckerpen@eaton.com

INDIA

MTL India,
No.36, Nehru Street, Off Old Mahabalipuram Road
Sholinganallur, Chennai- 600 119, India
Tel: +91 (0) 44 24501660 /24501857 Fax: +91 (0) 44 24501463
E-mail: mtlindiasales@eaton.com

ITALY

MTL Italia srl,
Via San Bovio, 3, 20090 Segrate, Milano, Italy
Tel: +39 02 959501 Fax: +39 02 95950759
E-mail: chmninfo@eaton.com

JAPAN

Cooper Industries Japan K.K.
MT Building 3F, 2-7-5 Shiba Diamon, Minato-ku
Tokyo, Japan 102-0012
Tel: +81 (0)3 6430 3128 Fax: +81 (0)3 6430 3129
E-mail: mtl-jp@eaton.com

NORWAY

Norex AS
Fekjan 7c, Postboks 147,
N-1378 Nesbru, Norway
Tel: +47 66 77 43 80 Fax: +47 66 84 55 33
E-mail: info@norex.no

RUSSIA

Cooper Industries Russia LLC
Elektrozavodskaya Str 33
Building 4
Moscow 107076, Russia
Tel: +7 (495) 981 3770 Fax: +7 (495) 981 3771
E-mail: mtlrussia@eaton.com

SINGAPORE

Eaton Electric (Singapore) Pte Ltd
100G Pasir Panjang Road
Interlocal Centre
#07-08 Singapore 118523
#02-09 to #02-12 (Warehouse and Workshop)
Tel: +65 6 645 9888 ext 9864/9865
Fax: 65 6 645 9811
E-mail: sales.mtlsing@eaton.com

SOUTH KOREA

Cooper Crouse-Hinds Korea
7F. Parkland Building 237-11 Nonhyun-dong Gangnam-gu,
Seoul 135-546, South Korea.
Tel: +82 6380 4805 Fax: +82 6380 4839
E-mail: mtl-korea@eaton.com

UNITED ARAB EMIRATES

Cooper Industries/Eaton Corporation
Office 205/206, 2nd Floor SJ Towers, off. Old Airport Road,
Abu Dhabi, United Arab Emirates
Tel: +971 2 44 66 840 Fax: +971 2 44 66 841
E-mail: mtlgulf@eaton.com

UNITED KINGDOM

Eaton Electric Limited,
Great Marlings, Butterfield, Luton
Beds LU2 8DL
Tel: +44 (0)1582 723633 Fax: +44 (0)1582 422283
E-mail: mtlenquiry@eaton.com

AMERICAS

Cooper Crouse-Hinds MTL Inc.
3413 N. Sam Houston Parkway W.
Suite 200, Houston TX 77086, USA
Tel: +1 800-835-7075 Fax: +1 866-298-2468
E-mail: mtl-us-info@eaton.com