

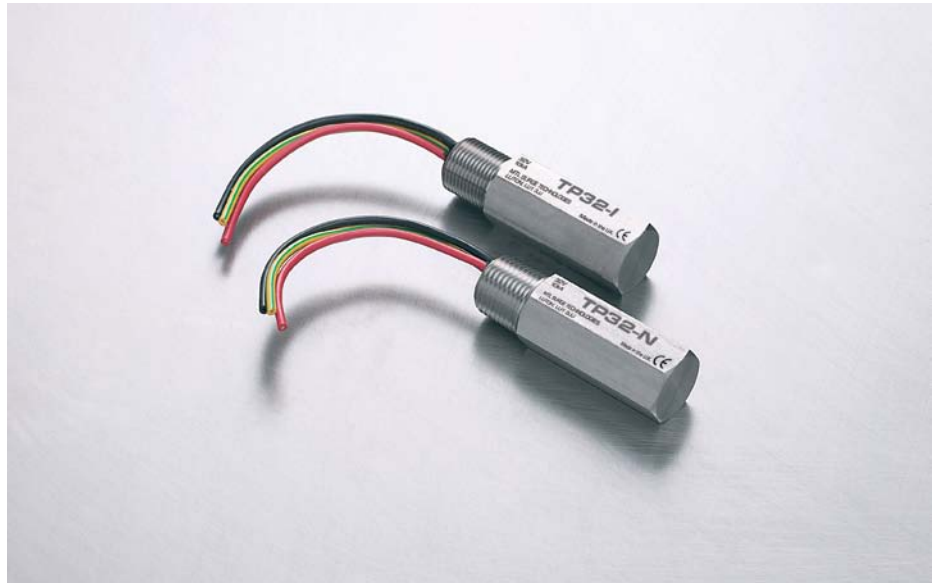

TP32 Series

Protects transmitters and smart transmitters from induced surges and transients on fieldbus cabling

- TP32 is a fieldbus specific surge protector designed to meet the requirements of IEC 61158-2:2004 & ANSI/ISA-50.02-2 1992
- TP32-T includes a TERMINATOR for fieldbus in addition to surge protection
- Easy and direct mounting — screws into spare conduit entry on the transmitter
- Parallel connection ensures 'transparent' operation — zero voltage drop across device
- ATEX approved, Certified FISCO Terminator
- 10 year product warranty



The **TP32 surge protection device** is specifically designed to protect process transmitters and devices on fieldbus systems. The TP32 builds on the high specification of the acclaimed TP48 range to provide a level of surge protection for fieldbus transmitters that is well in excess of the optional transient protection available from some transmitter manufacturers.

The **terminated TP32-T** has the same protection circuit as the standard product, but also includes a Foundation fieldbus termination circuit. This unique combination eliminates the need to purchase and install additional termination circuitry for the FF segment. The TP32-T provides excellent transient protection control and terminates the bus segment in one simple-to-install package. The termination circuit is designed to the requirements described in ANSI/ISA 50.02-2. Note: Two (and only two) terminators are required per bus segment.

The **all important earth connection** is made via the casing of the transmitter negating the need for a separate earth connection or ground stake at the transmitter. In operation, the TP32 makes sure that the transmitter electronics are never exposed to damaging transients between the lines and ground. Any surge current appearing as a series-mode or common-mode transient is converted into a common-mode voltage whereupon the transmitter electronics are temporarily raised to some higher voltage level before 'floating' down automatically (and without damage) to resume normal operation.

The **T32 protection network** is a hybrid design consisting of high-power, solid state electronics and a gas discharge tube which is capable of diverting surges up to 20kA. Encased in an ANSI 316 stainless steel enclosure, the TP32 exhibits unparalleled mechanical durability providing years of maintenance free operation in harsh environments. The enclosure is available threaded for all the common conduit entries. Versions are available for 1/2" NPT, 20mm ISO, and G 1/2" (BSP 1/2 inch) threaded entries.

Installation is very simple and can easily be carried out retrospectively to existing installations. By connecting in parallel to the transmitter circuit the TP32 does not interfere with the normal operation of the bus – passing AC or DC signals without adding increased voltage drop across the segment while consistently diverting surge currents safely to ground and clamping output voltages to safe levels.

Approvals for intrinsically safe, flameproof/ explosionproof and non incandive operation are available, in all gas groups and apparatus temperature classification up to T6.

The **TP32 is designed to meet the requirements** of IEC 61158-2:2000 and ANSI/ISA-50.02-2:1992 for 31.25kB/sec systems as used by FOUNDATION™ fieldbus, PROFIBUS-PA and WorldFIP.

FIELD DEVICE PROTECTION USING TP32

Non Hazardous Installation

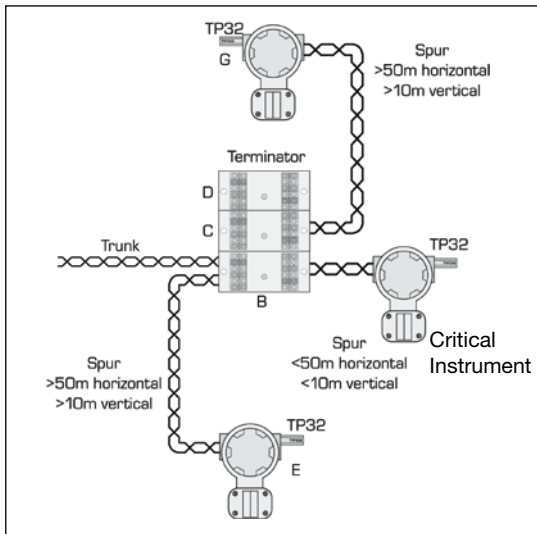

Install a TP32 on every instrument critical to the operation of the process system.

Install TP32 on each instrument with a spur length greater than 50m horizontal and 10m vertical.

For a detailed risk analysis (to minimize the number of protectors required) and guidance for total fieldbus system protection, please see TAN 1010.

Hazardous Area Explosionproof/Flameproof/Increased Safety

Install TP32-X-NDI (where X = thread type) on every instrument critical to the operation of the process.

Install TP32-X-NDI on each instrument with a spur length greater than 50m horizontal, 10m vertical.

See TAN 1010 for details of total fieldbus protection.

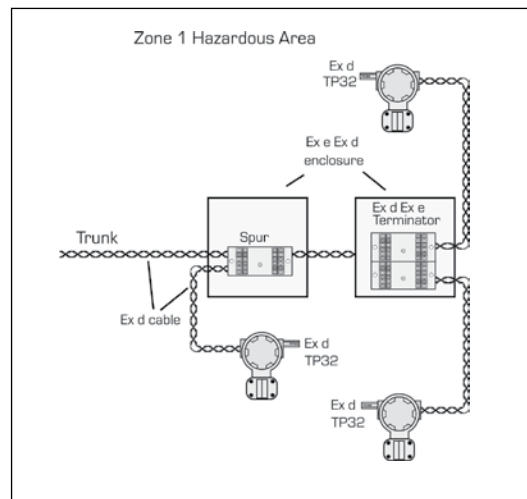

Hazardous Area Intrinsically Safe System; FISCO

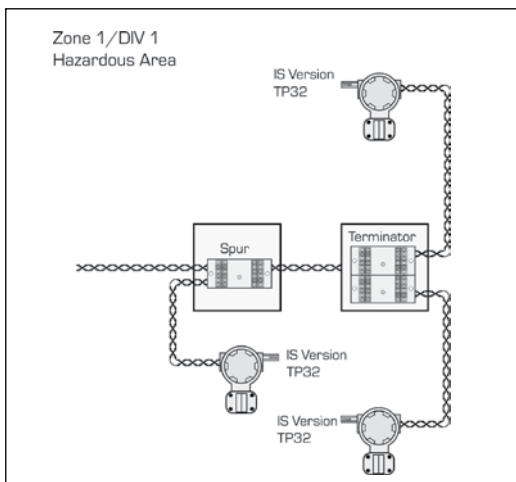

Install TP32-X-NDI (where X = thread type) on every instrument critical to the operation of the process.

Install TP32-X-NDI on each instrument with a spur length greater than 50m horizontal, 10m vertical.

See TAN 1010 for details of total fieldbus protection.

NOTE: The TP32 NDI is FISCO compatible.

NOTE: Protection at the host end of the trunk is mandatory, see FP32 datasheet and TAN 1010 for more information.

The given data is only intended as a product description and should not be regarded as a legal warranty of properties or guarantee. In the interest of further technical developments, we reserve the right to make design changes.



EUROPE (EMEA): +44 (0)1582 723633
enquiry@mtl-inst.com

THE AMERICAS: +1 800 835 7075
csinfo@mtl-inst.com

ASIA-PACIFIC: +65 6 487 7887
sales@mtlsing.com.sg

901-114 Rev K 070410

USE OF THE TP32-T TO TERMINATE A FIELDBUS TRUNK

Conventional Installation

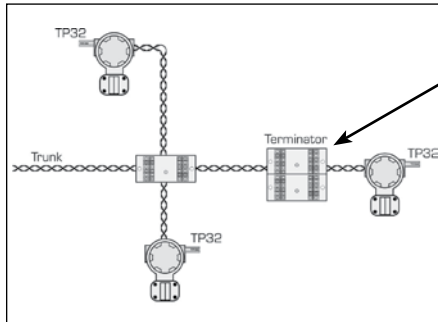

Junction block and terminator are required at the far end of a fieldbus trunk.

Installation Using TP32-T

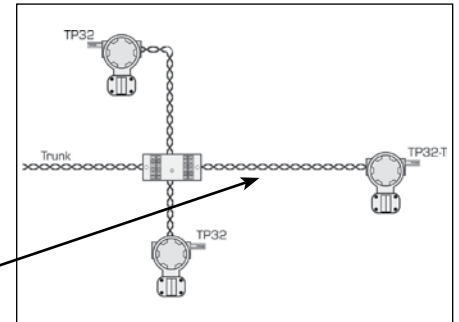

Use of TP32-T eliminates the need for an extra junction block and terminator.

Model		TP32 & TP32-T
Nominal voltage	U_n	32V
Rated voltage (MCOV)	U_c	35V
Nominal current	I_n	n/a
Nominal discharge current (8/20 μ s)	i_{sn}	3kA
Max discharge current (8/20 μ s)	I_{max}	20kA
Lightning impulse current (10/350 μ s)	I_{imp}	2.5kA
Residual voltage @ i_{sn}	U_p	46V
Voltage protection level @ 1kV/ μ s	U_p	<38V
Bandwidth	f_G	7.5MHz
Capacitance	C	50pF
Series resistance	R	n/a
Operating Temperature Range		-40°C to +85°C
Category tested		A2, B2, C1, C2, C3, D1
Overstressed fault mode $i_n=3kA$		12kA
Impulse durability (8/20 μ s)		10kA
Degree of protection		IP66
AC durability		1A _{rms} , 5T
Service conditions		80kPa - 160kPa 5% - 95% RH

APPROVALS

Country (Authority)	Standard No.	Certificate/File	Approved for	Product
EC (BASEEFA)	EN 50014:1997 + Amendments 1 & 2 EN 50020:1994, EN 50284:1999	BASEEFA04ATEX0251X	EEx ia IIC T6 (Tamb = -40 to 60°C) EEx ia IIC T5 (Tamb = -40 to 85°C) EEx ia IIC T4 (Tamb = -40 to 60°C)	TP32-N-NDI TP32-I-NDI TP32-G-NDI
EC (BASEEFA)	EN 50014:1997 + Amendments 1 & 2 EN 50018:2000 + Amendment 1	BASEEFA04ATEX0053X	EEx d IIC T6 (Tamb = -40 to 60°C) EEx d IIC T5 (Tamb = -40 to 80°C) EEx d IIC T4 (Tamb = -40 to 85°C)	TP32-N-NDI TP32-I-NDI TP32-G-NDI
Atex Directive 94/9/EC	BS EN 50021:1999	TML02ATEX0032X	Ex n II T6 (-40°C<Tamb<+60°C) EEx n II T5 (-40°C<Tamb<+85°C)	TP32-N TP32-I TP32-G
USA (FM)	Class Nos. 3600 (1998), 3610 (1999), 3611 (1999), 3615 (1989), 3810 incl. Supp 1 (1995-07 (1989-03), ANSI/NEMA 250 (1991), ISA-S12.0.01 (1999)	3011208	Intrinsically Safe: I, II, III/1/A-G, I/O/IIC Explosionproof: I/1/A-D Non-incendive: I/2/A-D, I/2/IIC Dust ignition proof: II,III/1/EFG Special protection: II/2/FG	TP32-N-NDI TP32-I-NDI TP32-G-NDI
Canada (FM)	C22.2 No. 157 C22.2 No. 213 C22.2 No. 142 C22.2 No. 94 C22.2 No. 30	3025374	Intrinsically Safe: I, II, III/1/A-G, I/O/IIC Explosionproof: I/1/A-D Non-incendive: I/2/A-D, I/2/IIC Dust ignition proof: II, III/1/EFG Special protection: II/2/FG	TP32 All
Global	IEC 60079-0:2004, IEC 60079-11:2006 IEC 61241-0:2004, IEC 61241-1:2004	IECEx BAS 07.0045X	Ex ia IIC T4/T5/T6 Ex tD A20 IP6X T85°C/T100°C/T135°C	TP32-X-NDI TP32-T-X-NDI

The given data is only intended as a product description and should not be regarded as a legal warranty of properties or guarantee. In the interest of further technical developments, we reserve the right to make design changes.



EUROPE (EMEA): +44 (0)1582 723633
enquiry@mtl-inst.com

THE AMERICAS: +1 800 835 7075
csinfo@mtl-inst.com

ASIA-PACIFIC: +65 6 487 7887
sales@mtlsing.com.sg

901-114 Rev K 070410

SPECIFICATION

All figures typical at 77°F (25°C) unless otherwise stated

Maximum surge current

20kA peak (8/20µs waveform)

Leakage current

Line-line: < 1µA at working voltage

Line-earth: < 1µA at 120V common-mode

Working voltage

±32V dc maximum

±120V peak (or DC) maximum common-mode

Maximum continuous operating voltage

35V

Limiting voltage

Line-line with 250mm cable:

< 49V (10A, 10/1000µs pulse)

Line-earth with 75mm cable:

<635V (3kA, 8/20µs waveform)

<635V (6kV, 1.2/50µs waveform)

Line resistance

No resistance introduced into the loop

Capacitance

Line-line:< 50pF

Line-earth:< 100pF

Terminator (TP32-T only): 100 ohm, 1µF

Attenuation

7.8KHz–7.5MHz monotonic & better than -1dB typical bandwidth, 150MHz on 100W system

Ambient temperature limits

T6 -40°F to +140°F (-40°C to +60°C)

T5 -40°F to +185°F (-40°C to +85°C)

Humidity

5% to 95% RH (non-condensing)

Electrical connections

3 flying leads: line 1 & line 2 plus non-polarised earth

Wire size: 32 / 0.2 (1.0mm², 18 AWG)

Lead length: 250mm minimum supplied
≤75mm recommended

Casing

ANSI 316 stainless steel hexagonal bar stock, male thread

Threads

TP32-N 1/2" NPT

TP32-I 20mm ISO (M20 x 1.5)

TP32-G G 1/2" (BSP 1/2 inch)

Weight

175g (6.2oz)

Dimensions

See figure 1

ATEX compliance

See Approvals table for details

EMC compliance

BS EN 61643-1

Electrical Safety

EEx ia IIC T6, Ceq=0, Leq=0; the unit can be connected without further certification into any intrinsically safe loop with open circuit voltage <30V and input power <1.2W.

EEx ia IIC T4, Ceq=0, Leq=0; the unit can be connected into any FISCO application with the following input parameters Pi=5.32W.

EEx d IIC T6; the unit is apparatus-approved to explosionproof (flameproof) standards, and can be fitted into a similarly approved housing.

SIL INFORMATION

Failure rates according to IEC 61508

	λ_{SD}	λ_{DD}	λ_{DU}
TP32	0 FIT	12 FIT	5 FIT

The user of the TP series can utilize these failure rates in a probabilistic model of a safety instrumented function (SIF) to determine the suitability in part for safety instrumented system (SIS) usage in a particular safety integrity level. A full table of failure rates is presented in the EXIDA report (section 4.4) along with all assumptions.

*The Residual Effect failures are included in the Safe Undetected failure category according to IEC 61508. Note that these failures alone will not affect system reliability or safety and should therefore not be included in spurious trip calculations.

Safe Failure Fraction needs to be calculated on (sub)system level.

A complete copy of the EXIDA report can be downloaded at www.mtl-inst.com.

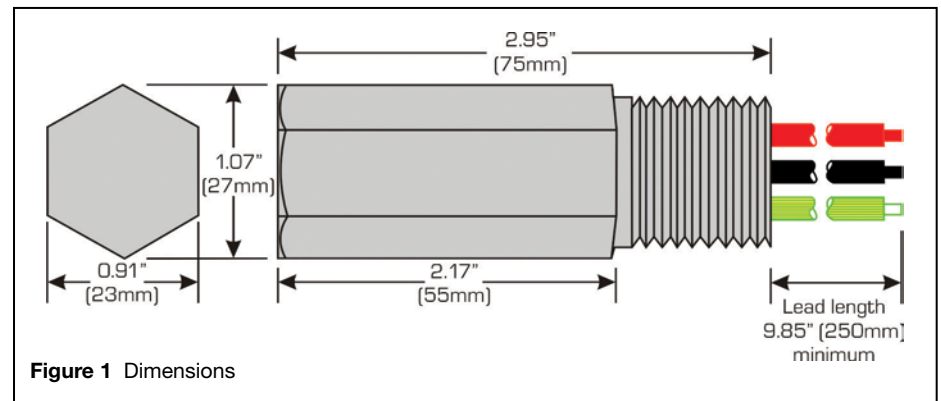

Figure 1 Dimensions

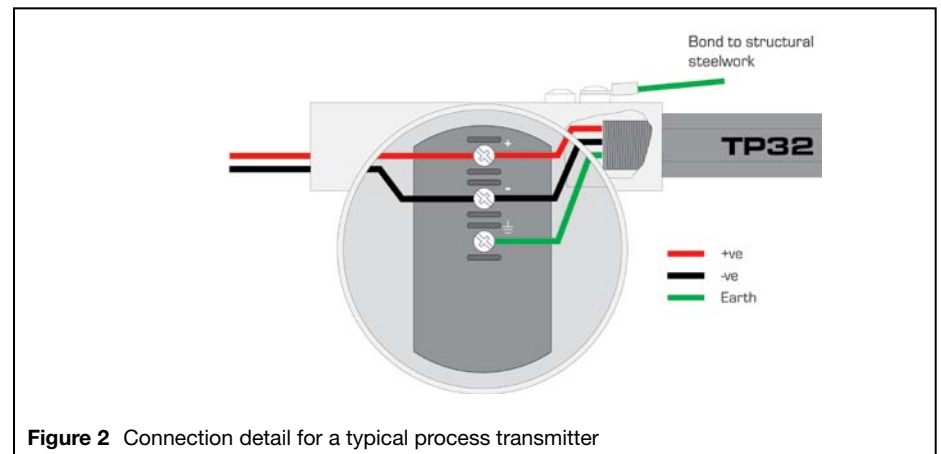

Figure 2 Connection detail for a typical process transmitter

TO ORDER SPECIFY -

TP32	TP32-T	
TP32-N	TP32-T-N	1/2" NPT thread
TP32-N-NDI	TP32-T-N-NDI	1/2" NPT thread, with EEx ia, EEx d, approval
TP32-I	TP32-T-I	20mm ISO thread
TP32-I-NDI	TP32-T-I-NDI	20mm ISO thread, with EEx ia, EEx d, approval
TP32-G	TP32-T-G	G 1/2" (BSP 1/2 inch)
TP32-G-NDI	TP32-T-G-NDI	G 1/2" (BSP 1/2 inch), with EEx ia, EEx d, approval

The given data is only intended as a product description and should not be regarded as a legal warranty of properties or guarantee. In the interest of further technical developments, we reserve the right to make design changes.



EUROPE (EMEA): +44 (0)1582 723633
enquiry@mtl-inst.com

THE AMERICAS: +1 800 835 7075
csinfo@mtl-inst.com

ASIA-PACIFIC: +65 6 487 7887
sales@mtlsing.com.sg

901-114 Rev K 070410