

9465-ET

10/100Mb Media Converter



Instruction Manual



CONTENTS

- 1. FEATURES..... 1**
- 2 DESCRIPTION..... 2**
- 3 INSTALLATION..... 2**
 - 3.1 Protection..... 2**
 - 3.2 Mechanical mounting..... 2**
 - 3.3. Electrical connections 3**
 - 3.4 Safe-area mounted EN60079-28 "op is" applications 4**
- 4. ENVIRONMENTAL 4**
- 5 WASTE REMOVAL INFORMATION..... 4**
- 6 ACCESSORIES..... 4**
- 7 APPROVALS..... 5**
- 8 FM CERTIFICATION INFORMATION 5**
- 9 ATEX & IECEx CERTIFICATION INFORMATION 6**



1. FEATURES

- ◆ Intrinsically Safe ATEX / IECEx certified, FM / FMC approved
- ◆ Ga Ex ia IIC T4 GD (surface), Ma Ex ia I M1 (mining)
- ◆ Zone 1/ Division 1 mounting in a suitable enclosure
- ◆ Input voltage: 12V dc (10 – 15.4V)
- ◆ Input current: 160mA
- ◆ Extended temperature range (-20°C...+70°C)
- ◆ PoEx™ - "Power over Ethernet" powered device option - accepts module supply via the Cat5e cable*
- ◆ 10/100Mb Ethernet twisted pair (Cat5e) RJ45 Connection (100m max)
- ◆ Fibre Optic connections:
 - ST style 62.5/125µm Multimode (9465-ET-M-ST)
 - SC style 62.5/125µm Multimode (9465-ET-M-SC)
 - SC style 9µm Single-mode (9465-ET-S-SC)
- ◆ Extended distance through the use of 1300nm optics – Typically:
 - 5Km @ 10Mbps over 62.5/125 fibre cable
 - 2Km @ 100Mbps over 62.5/125 fibre cable
- ◆ Status LED's For:
 - 'Power On'
 - Fibre Optic 'Link 10Mb' or 'Link 100Mb' Established
 - Fibre Optic 'Tx/Rx Activity'
 - Copper UTP 'Link 10Mb' or 'Link 100Mb' Established
 - Copper UTP 'Tx/Rx Activity'
- ◆ Transparent operation – 10/100Mbps, Full/Half Duplex with Auto-Negotiation
- ◆ Supports IEEE 802.3: 10Base-T, 10Base-FL, 100Base-TX and 100Base-FX/SX
- ◆ DIN-rail mounting module

**Note – PoEx is a simple adaptation of the IEEE 802.3af Power over Ethernet (PoE) standard to bring the benefits to the 9460 Range of Hazardous Area devices. This allows two spare pairs in the existing Cat5e cable to distribute the power supply from a 9466-ET Ethernet Switch (Power Sourcing Equipment – PSE) to each of the devices connected to its five ports (PD – Powered Device). This adaptation is necessary due to restrictions for Hazardous Area use. It is not implied that the device conforms to the 802.3af (PoE) standard.*

2 DESCRIPTION

The 9465-ET 10/100Mbps Copper to Fibre Optic Media Converter allows an Ethernet network to be extended over a greater distance. The fibre optic link may be up to 2Km in length when running at 100Mbps and due to the use of 1300nm optics an extended distance of 5Km is achievable at 10Mbps. Longer distances are obtained by simply connecting a 9466 (10/100Mbps Ethernet Switch) between two 9465-ET media converters, effectively giving a 'repeater' function (This also provides 3x UTP ports available for local network connectivity), this can be repeated as required.

The use of fibre optics gives exceptional immunity to noise and electrical interference, it is also used when connecting a Hazardous Area network to a Zone 2 / Safe Area network or device.

3 INSTALLATION



WARNING: This equipment must be installed, operated and maintained only by trained competent personnel and in accordance with all appropriate international, national and local standard codes of practice and site regulation for intrinsically safe apparatus and in accordance with the instructions contained here. See also Sections 7, 8 & 9 for approvals and important conditions of safe use.

3.1 Protection

The module requires mounting within an enclosure providing a degree of protection of at least IP6x, in accordance with EN60529 and in a manner that does not impair the existing creepage and clearance distances. The enclosure must also comply with the requirements of Clauses 7 and 8 of EN50014 and be sealed to prevent the ingress of dust.

3.2 Mechanical mounting

3.2.1 DIN rail mounting

The module will 'snap-fit' onto standard DIN rail (TS35) to EN 50022. Height off rail - including any connectors but excluding cables = 115mm.

Tilt the module to engage the top DIN rail clips then rotate down and press to the DIN rail until the lower spring clip is properly engaged.

3.2.2 Flat panel mounting

The module has two fixing holes to enable it to be mounted with two M3.5 screws. Use the dimension diagram below to establish hole positions. Depth - including connectors but excluding cables = 120mm.

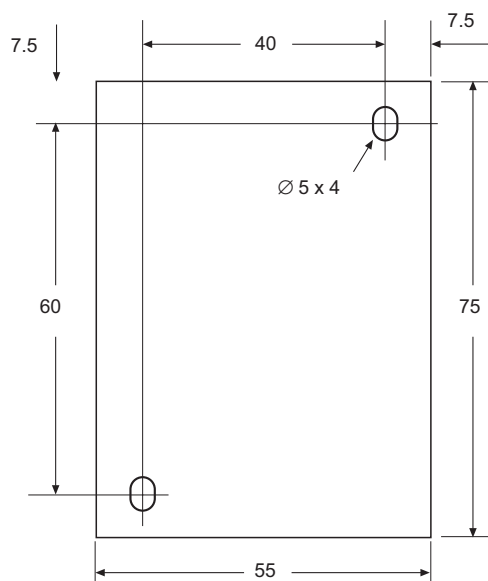

3.3. Electrical connections

DC power can be supplied to the equipment through the front panel screw terminals or alternatively using the Power over Ethernet (PoEx) option where DC power is supplied from a 9466-ET module down the Ethernet Cat5e (or Cat6) cable into the RJ45 connector on the front panel.



WARNING: Whichever wiring method of powering the modules is used, the supply to them must be derived from a suitably certified, intrinsically safe supply.

3.3.1 Screw Terminals

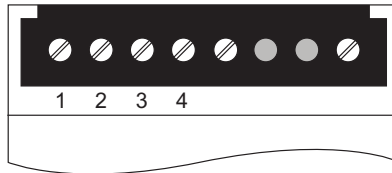

DC power input

Note: An alternative is to supply the power via the Cat5e cable to the RJ45 connector (PoEx)

Terminal No.	Function	When using PoEx – no supply is required on these terminals.
1	+12V dc in	
2	+12V dc in	
3	0V	
4	0V	
5 – 8	No connection	

Note: 1. (Terminals 1+2, 3+4 linked internally)

3.3.2 Front Panel Connectors

10/100 BASE-T Ethernet RJ45

Pin No.	Function	When using PoEx – no supply is required on screw terminals 1 to 4 - see above.
1	RX +	
2	RX –	
3	TX +	
4	Supply 12V - PoEx	
5	Supply 12V - PoEx	
6	TX –	
7	Supply 0V - PoEx	
8	Supply 0V - PoEx	

When connecting the Cat5e cable to a 9466 Ethernet switch, or other device that supports Auto MDI/MDI-X, a straight connected RJ45 cable is used, a cross-over cable is only required if the other device does not support this auto detect mode.

It is recommended that Cat5e cables for Hazardous Area Zone 1 use are 'Blue' in colour and are of good quality (see accessories section), the Safe Area cables being a colour other than blue to aid identification.

10/100 BASE-FL ST(or SC) - Fibre Optic

Port	Function
Top	TX
Bottom	RX

The fibre optic cable is connected to the ST (or SC) style ports on the front panel, the top one of which is transmit (TX), the lower one receive (RX). When connecting fibre cable between a pair of media converters a cross-over is required – i.e: TX on one module connects to RX on the other module.

3.4 Safe-area mounted EN60079-28 “op is” applications

The 9465-ET may be used as a Safe Area mounted, inherently safe ‘op is’ device. Its optical output, conforming to EN60079-28, may go into or through a Zone 2, Zone 1 or Zone 0 hazardous area, but its copper connections (12V power and RJ45 Ethernet) may not.

In this situation the 9465-ET device may be powered from any non-IS 12VDC power supply and the RJ45 Ethernet port connected to unspecified equipment. When used as such, the CSL-OPTISAFE certification label, which is supplied, must be affixed over the centre part of the existing 9400 certification label so that it covers the original Hazardous Area marking.

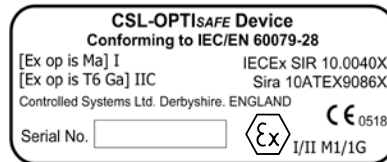

CAUTION: A device once operated in this way may not then be used in Zone 1/Division 1 mounted Intrinsically Safe applications as it cannot be guaranteed that internal safety components have not been subjected to transients outside their rating.

4. ENVIRONMENTAL

Operating Temperature	-20°C...+70°C
Storage Temperature	-20°C...+70°C
Humidity	5...95% RH, non condensing

5 WASTE REMOVAL INFORMATION



The electronic equipment within must not be treated as general waste. By ensuring that this product is disposed of correctly you will be helping to prevent potentially negative consequences for the environment and human health, which could otherwise be caused by incorrect waste handling of this product. For more detailed information about the take-back and recycling contact **MTL**.

6 ACCESSORIES

For interconnecting the 9460-ET range of products, we offer approved RJ45 Cat5e UTP cables in various standard lengths (0.5...100m) and rugged multi-core fibre optic cables.

Ordering details

Copper Twisted Pair UTP Patch Cable (Blue) pre-terminated with RJ45 – RJ45 connectors

Part No. CSL9405-xx (-xx is used to signify the length of the cable)

8-Core Fibre Optic Cable 62.5/125um pre-terminated with ST – ST connectors

Part No. CSL9066-8-50 (eg.: '-50' suffix signifies a 50metre cable.)

Note that long lengths of fibre cable are supplied on drums with a Kevlar core ‘pulling eye’ to aid installation and protective end covers on the ST terminations.

7 APPROVALS

The operating parameters must not exceed those as detailed on the certificate.

Region	Europe (ATEX)	International IECEx	USA	Canada
Authority	SIRA	SIRA	FM	FMC
Standard	EN 60079-0:2006, EN 60079-11:2007, IEC 60079-26:2006, EN 60079-28:2007, EN 50303:2000, IEC 61241-0:2004, IEC 61241-11:2005	IEC 60079-0:2004, IEC 60079-11:2006, IEC 61241-0:2004, IEC 61241-1:2004	3600 3610 3810	C22.2 No. 61010.1:2004 C22.2 No. 157:1992 CAN/CSA-E60079-0:2007 CAN/CSA-E60079-11:2002
Approved for	⊕ II 1GD Ga Ex ia IIC T4 Ex iaD 20 T135°C Ga Ex ia op is IIC T4 (Ta = -40°C to +70°C)* ⊕ I M1 Ma Ex ia I Ma Ex ia op is I (Ta = -40°C to +70°C)	Ga Ex ia IIC T4 Ex iaD 20 T135°C Ma Ex ia I (Ta = -40°C to +70°C)*	IS/I/1/ABCD/T4 Ta=70°C I/O/AEx ia IIC T4 Ta=70°C	IS/I/1/ABCD/T4 Ta=70°C I/O/AEx ia IIC T4 Ta=70°C
Cert. no.	Sira 07ATEX2064X	IECEx SIR 07.0042X	3034995	3034995C

* (see specification for operating temperature range)

- ◆ 2004/108/EC EMC Directive
- ◆ 2006/95/EC Low Voltage Directive

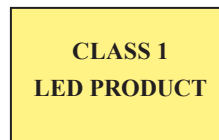

8 FM CERTIFICATION INFORMATION

Special Condition of Use - Factory Mutual (USA & Canada)

1. The Model 9465-ET shall be installed in compliance with the enclosure, mounting, spacing and segregation requirements of the ultimate application.
2. The Model 9465-ET shall be excluded from use in environments containing chemical vapours of the Ketone or Ester families.

9 ATEX & IECEx CERTIFICATION INFORMATION

The following information is in accordance with the Essential Health and Safety Requirements (Annex II) of the EU Directive 94/9/EC [the ATEX Directive - safety of apparatus] and is provided for those locations where the ATEX Directive is applicable.

General

- a. This equipment must only be installed, operated and maintained by competent personnel. Such personnel shall have undergone training, which included instruction on the various types of protection and installation practices, the relevant rules and regulations, and on the general principles of area classification. Appropriate refresher training shall be given on a regular basis. [See clause 4.2 of EN 60079-17].
- b. This equipment has been designed to provide protection against all the relevant additional hazards referred to in Annex II of the directive, such as those in clause 1.2.7.
- c. This equipment has been designed to meet the requirements of intrinsically safe electrical apparatus in accordance with EN 60079-0, EN 60079-11 and EN 60079-26.

Installation

- a. reference to the IEC code of practice IEC 60079-14. In addition, particular industries or end users may have specific requirements relating to the safety of their installations and these requirements should also be met. For the majority of installations the Directive 1999/92/EC [the ATEX Directive - safety of installations] is also applicable.
- b. Unless already protected by design, this equipment must be protected by a suitable enclosure against:
 - i) mechanical and thermal stresses in excess of those noted in the certification documentation and the product specification.
 - ii) aggressive substances, excessive dust, moisture and other contaminants.
- c. This equipment is intrinsically safe electrical apparatus and is normally mounted in a hazardous area. When mounted in a Zone 1 location the apparatus must be provided with an enclosure, which offers an additional degree of protection appropriate to the area classification.

Read also the Special Conditions for Safe Use for any additional or more specific information.

Special Conditions for Safe Use

1. When used with Group I gases, the Modules shall each be mounted within an enclosure providing a degree of protection of at least IP54, in accordance with EN 60529, and in a manner that does not impair the existing creepage and clearance distances. The enclosure shall also comply with the requirements of Clauses 7 and 8 of EN 60079-0:2006.
2. The connectors do not meet the ingress protection rating of IP20, therefore, this shall be taken into consideration during the installation of the 9400 Series Ethernet Modules when used with Group II gases, and each module shall be provided with an enclosure that is commensurate with the environment into which it is installed.
3. The supply to the modules must be derived from a suitably certified, intrinsically safe supply.

Inspection and maintenance

- a. Inspection and maintenance should be carried out in accordance with European, national and local regulations which may refer to the IEC standard IEC 60079-17. In addition specific industries or end users may have specific requirements which should also be met.
- b. Access to the internal circuitry must not be made during operation.

Repair

This product cannot be repaired by the user and must be replaced with an equivalent certified product.

Marking

Each device is marked in accordance with the Directive and CE marked with the Notified Body Identification Number.

This information applies to products manufactured during or after the year 2010.

9400 Series Ethernet 

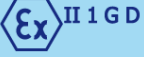
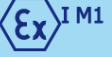

9465-ET-M-ST 10/100 Media Converter

 Intrinsicly Safe CL I, DIV 1, GPA-D; CL I ZN 0
 AEx ia IIC (US), Ex ia IIC (Canada);
 Install per Control Drawing: 9400 System
 Temperature Class T4, -40°C ≤ Ta ≤ +70°C

Sira 07ATEX2064X  
 IECEx SIR 07.0042X

Serial No.

Ma Ex ia op is I
 Ga Ex ia op is IIC T4 (Ta=-40°C to +70°C)
 Ex iaD 20 T135°C



Made in Derbyshire, England
 CONTROLLED SYSTEMS LIMITED
 In partnership with MEASUREMENT TECHNOLOGY LTD.  

WARNING - Electrostatic precaution - Clean only with a damp cloth.

9400 Series Ethernet 



9465-ET-M-SC 10/100 Media Converter

 Intrinsicly Safe CL I, DIV 1, GPA-D; CL I ZN 0
 AEx ia IIC (US), Ex ia IIC (Canada);
 Install per Control Drawing: 9400 System
 Temperature Class T4, -40°C ≤ Ta ≤ +70°C

Sira 07ATEX2064X  
 IECEx SIR 07.0042X

Serial No.

Ma Ex ia op is I
 Ga Ex ia op is IIC T4 (Ta=-40°C to +70°C)
 Ex iaD 20 T135°C



Made in Derbyshire, England
 CONTROLLED SYSTEMS LIMITED
 In partnership with MEASUREMENT TECHNOLOGY LTD.  

WARNING - Electrostatic precaution - Clean only with a damp cloth.

9400 Series Ethernet 



9465-ET-S-SC 10/100 Media Converter

 Intrinsicly Safe CL I, DIV 1, GPA-D; CL I ZN 0
 AEx ia IIC (US), Ex ia IIC (Canada);
 Install per Control Drawing: 9400 System
 Temperature Class T4, -40°C ≤ Ta ≤ +70°C

Sira 07ATEX2064X  
 IECEx SIR 07.0042X

Serial No.

Ma Ex ia op is I
 Ga Ex ia op is IIC T4 (Ta=-40°C to +70°C)
 Ex iaD 20 T135°C

Made in Derbyshire, England
 CONTROLLED SYSTEMS LIMITED
 In partnership with MEASUREMENT TECHNOLOGY LTD.  

WARNING - Electrostatic precaution - Clean only with a damp cloth.

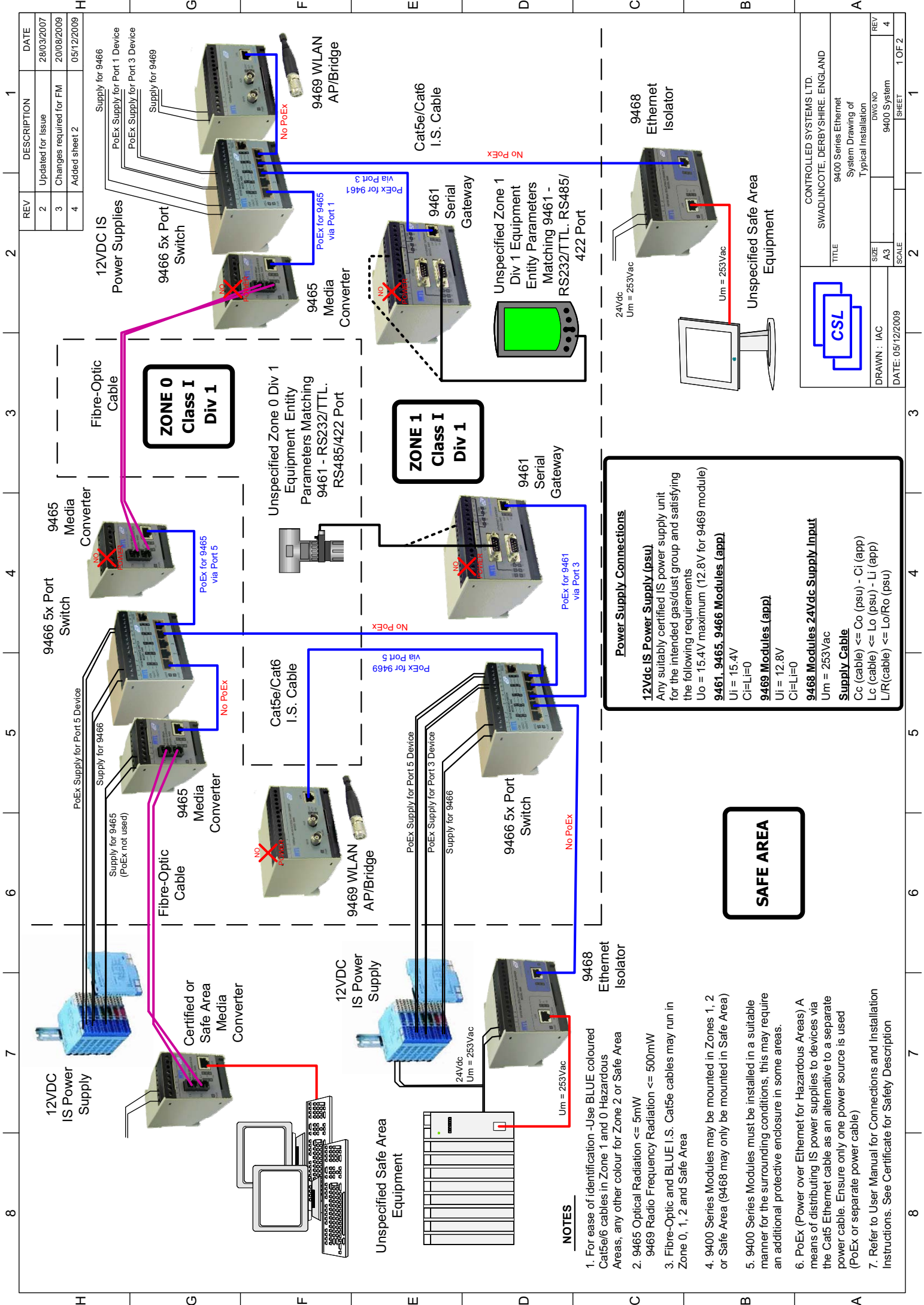

REV	DESCRIPTION	DATE
2	Updated for Issue	28/03/2007
3	Changes required for FM	20/08/2009
4	Added sheet 2	05/12/2009

1	2	3	4	5	6	7	8
---	---	---	---	---	---	---	---

H	G	F	E	D	C	B	A
---	---	---	---	---	---	---	---

Power Supply Connections

12Vdc IS Power Supply (psu)
 Any suitably certified IS power supply unit for the intended gas/dust group and satisfying the following requirements
 Uo = 15.4V maximum (12.8V for 9469 module)
9461, 9465, 9466 Modules (app)
 Ui = 15.4V
 Ci=Li=0

9469 Modules (app)
 Ui = 12.8V
 Ci=Li=0

9468 Modules 24Vdc Supply Input
 Um = 253Vac

Supply Cable
 Cc (cable) <= Co (psu) - Ci (app)
 Lc (cable) <= Lo (psu) - Li (app)
 L/R (cable) <= Lo/Ro (psu)

SAFE AREA

NOTES

- For ease of identification -Use BLUE coloured Cat5e/6 cables in Zone 1 and 0 Hazardous Areas, any other colour for Zone 2 or Safe Area
- 9465 Optical Radiation <= 5mW
9469 Radio Frequency Radiation <= 500mW
- Fibre-Optic and BLUE I.S. Cat5e cables may run in Zone 0, 1, 2 and Safe Area
- 9400 Series Modules may be mounted in Zones 1, 2 or Safe Area (9468 may only be mounted in Safe Area)
- 9400 Series Modules must be installed in a suitable manner for the surrounding conditions, this may require an additional protective enclosure in some areas.
- PoEx (Power over Ethernet for Hazardous Areas) A means of distributing IS power supplies to devices via the Cat5 Ethernet cable as an alternative to a separate power cable. Ensure only one power source is used (PoEx or separate power cable)
- Refer to User Manual for Connections and Installation Instructions. See Certificate for Safety Description

		CONTROLLED SYSTEMS LTD. SWADLINCOTE, DERBYSHIRE, ENGLAND	
DRAWN: IAC		TITLE 9400 Series Ethernet System Drawing of Typical Installation	
DATE: 05/12/2009	SCALE A3	DWG NO 9400 System	REV 4
SHEET 1 OF 2		SHEET 1 OF 2	

The 9461-ET Ethernet Gateway Module

Description	Location	Input Parameters				Output Parameters			
		Ui (V)	Ci (uF)	Li (mH)	Uo (V)	Io (mA)	Po (mW)	Co (uF)	Lo (mH)
Optional Input Power Supply	T1, T2 w.r.t. T3, T4	15.4	0	0	-	-	-	-	-
RS485/422 Port 3	T5 w.r.t. T10 T8 w.r.t. T10 T17 w.r.t. T11 T14 w.r.t. T15	7.2	0	0	5.88	111	163	20	3.00
RS485/422 Port 4	T11 w.r.t. T15 T12 w.r.t. T15 T13 w.r.t. T15 T14 w.r.t. T15	7.2	0	0	5.88	111	163	20	3.00
TLRS232 Port 1; CON 1	Pin 9 w.r.t. Pin 5 Pin 3 w.r.t. Pin 5 Pin 4 w.r.t. Pin 5 Pin 7 w.r.t. Pin 5 Pin 2 w.r.t. Pin 5 Pin 6 w.r.t. Pin 5 Pin 8 w.r.t. Pin 5	0	0	0	5.88	188	276	20	2.26
TLRS232 Port 2; CON 2	Pin 3 w.r.t. Pin 5 Pin 4 w.r.t. Pin 5 Pin 7 w.r.t. Pin 5 Pin 2 w.r.t. Pin 5 Pin 6 w.r.t. Pin 5 Pin 8 w.r.t. Pin 5	0	0	0	5.88	16	24	20	138
RJ45 Connector (10/100 Base T) Without PoE+	Pin 1 w.r.t. Pin 5	12.5	0	0	3.15	3.4	2.7	50	1000
RJ45 Connector (10/100 Base T) With PoE+	Pin 1 w.r.t. Pin 5	12.5	0	0	3.15	3.4	2.7	50	1000

The 9466-ET 10/100 5-Port Switch

Desc.	Loc.	Input Parameters				Output Parameters			
		Ui (V)	Ci (uF)	Li (mH)	Uo (V)	Io (mA)	Po (mW)	Co (uF)	Lo (mH)
Optional Supply Input	T1, T2 w.r.t. T3, T4	15.4	0	0	-	-	-	-	-
PoE 8-way Terminals*	T5 w.r.t. T7 T8 w.r.t. T9 T10 w.r.t. T11 T14 w.r.t. T15	15.4	0.075	0	-	-	-	-	-
MH-DIN 8-way Management Port	Pin 5 w.r.t. Pin 6 Pin 4, 3 & 4 w.r.t. Pin 5 & 6	12.5	0	0	3.15	3.4	2.7	50	1000
RJ45 Connector 10/100 Base T	RJ45 Conn	15.4	0.075	0	Refer to parameters of IS power supply connected to T6 w.r.t. T7 for the output parameters.	-	-	-	-
RJ45 Connector 10/100 Base T	RJ45 Conn B	15.4	0.075	0	Refer to parameters of IS power supply connected to T8 w.r.t. T9 for the output parameters.	-	-	-	-
RJ45 Connector 10/100 Base T	RJ45 Conn C	15.4	0.075	0	Refer to parameters of IS power supply connected to T10 w.r.t. T11 for the output parameters.	-	-	-	-
RJ45 Connector 10/100 Base T	RJ45 Conn D	15.4	0.075	0	Refer to parameters of IS power supply connected to T12 w.r.t. T13 for the output parameters.	-	-	-	-
RJ45 Connector 10/100 Base T	RJ45 Conn E	15.4	0.075	0	Refer to parameters of IS power supply connected to T14 w.r.t. T15 for the output parameters.	-	-	-	-

* Not to be used if PoE+ is supplied at the 9468-ET Module.

The 9465-ET 10/100 Media Converter

Description	Location	Input Parameters				Output Parameters			
		Ui (V)	Ci (uF)	Li (mH)	Uo (V)	Io (mA)	Po (mW)	Co (uF)	Lo (mH)
Optional Supply Input	T1, T2 w.r.t. T3, T4	15.4	0	0	-	-	-	-	-
RJ45 Connector (10/100 Base T) Without PoE+	Five-Optic Transmitter	-	-	-	-	-	5 max	-	-
RJ45 Connector (10/100 Base T) With PoE+	Five-Optic Transmitter	15.4	0.075	0	Refer to parameters of IS power supply connected to T1, T2 w.r.t. T3, T4 for the output parameters.	-	-	-	-

The 9468-ET Ethernet Isolator Module

Description	Location	Um (Vdc)	Ci (uF)	Li (mH)
Safe area supply input RJ45 from safe area 10/100 Base T	T1, T2 w.r.t. T3, T4	253	0	0

The 9468-ET may be connected to a single IS power supply at T14 and T15 if power-over-Ethernet (PoE+) is required through pins 4, 5, 7 & 8 of the RJ45 connectors unless PoE+ is supplied at the 9466-ET Module.

Description	Location	Input Parameters				Output Parameters			
		Ui (V)	Ci (uF)	Li (mH)	Uo (V)	Io (mA)	Po (mW)	Co (uF)	Lo (mH)
IS Power Supply (optional PoE+)*	T14 w.r.t. T15	15.4	0.075	0	-	-	-	-	-
RJ45 by/for Intranet area 10/100 Base T**	T14 w.r.t. T15	15.4	0.075	0	Refer to parameters of IS power supply connected to T14 w.r.t. T15 for the output parameters.	-	-	-	-

* Power supply may only be connected if PoE+ is not already connected at the 9466 Floodlit.
 ** RJ45 by/for Intranet area 10/100 Base T connectors on other 9400 Series Ethernet modules, each powered from a single intranet safety supply. Connection to other Ethernet systems requires special consideration and is outside the scope of this certificate; see installation drawing for connection details.

The 9469-ET WLAN AP/Bridge

Description	Location	Input Parameters				Output Parameters			
		Ui (V)	Ci (uF)	Li (mH)	Uo (V)	Io (mA)	Po (mW)	Co (uF)	Lo (uH)
Optional Supply Input	Terminal T1, T2 w.r.t. T3, T4	12.8	0	0	-	-	-	-	-
RJ45 Connector (10/100 Base T) Without PoE+	Refer to parameters of IS power supply connected to T1, T2 w.r.t. T3, T4 for the output parameters.	12.8	0.075	0	-	-	-	-	-
RJ45 Connector (10/100 Base T) With PoE+	Refer to parameters of IS power supply connected to T1, T2 w.r.t. T3, T4 for the output parameters.	12.8	0.075	0	Refer to parameters of IS power supply connected to T1, T2 w.r.t. T3, T4 for the output parameters.	-	-	-	-
Antenna A	Antenna A	-	-	-	-	-	900 max RF	-	-
Antenna B	Antenna B	-	-	-	-	-	500 max RF	-	-

NOTE: RJ45 ETHERNET PORTS* ARE INTENDED FOR CONNECTION ONLY TO OTHER 9400 SERIES MODULES SHOWN ON THIS DRAWING.

*(With the exception of 9468-ET Safe Area port)



CONTROLLED SYSTEMS LTD.
 SWADLINCOTE, DERBYSHIRE, ENGLAND

TITLE
 9400 Series Ethernet
 System Drawing of
 Typical Installation

DRAWN : IAC	SCALE	REV	DWG NO
DATE: 05/12/2009		4	9400 System

SHEET 2 OF 2

MTL Instruments Pty Limited

9 /12 Billabong Street
Stafford
Queensland 4053
Australia
Tel: + 61 1300 308 374 Fax: + 61 1300 308 463
E-mail: enquiries@mtlaus.com.au

Cooper Electric (Shanghai) Co.Ltd.

Room 2001, China Life Tower
16 Chao Yang Men Wai Street
Chao Yang District, Beijing
China 100020
Tel: + 86 10 5980 0288 Fax: + 86 10 8562 5725
E-mail: bjsales@mtl-inst.cn

MTL Instruments sarl

Les Carrés du Parc
10 rue des Rosiéristes
69410 Champagne au Mont d'Or
France
Tel: +33 (0)4 78 64 98 32 Fax: +33 (0)4 78 35 79 41
E-mail: info@mtl-inst.fr

MTL Instruments GmbH

An der Gumpgesbrücke 17
D-41564 Kaarst
Germany
Tel: +49 (0)2131 718930 Fax: +49 (0)2131 7189333
E-mail: info@mtl.de

MTL India

No. 36, Nehru Street
Off Old Mahabalipuram Road
Sholinganallur
Chennai - 600 119
India
Tel: + 91 (0)44 24501660/24501857 Fax: + 91 (0)44 24501463
E-mail: sales@mtlindia.com

MTL Italia srl

Via Cantù 11
I - 20092 Cinisello Balsamo MI
Italy
Tel: +39 (0)2 61802011 Fax: +39 (0)2 61294560
E-mail: info@mtl-inst.it

MTL Instruments KK

MT Building 3F
2-7-5 Shiba Daimon
Minato-ku Tokyo
Japan 105-0012
Tel: +81 (0)3 6430 3128 Fax: +81 (0)3 6430 3129
E-mail: sales@mtlkk.co.jp

Cooper Crouse-Hinds Korea

12F, Vision Tower
707-2 Yeoksam-dong, Gangnam-gu
Seoul 135-080
South Korea
Tel: +82 2 3484 6795 Fax: +82 2 3484 6778

MTL Instruments BV

MTL Instruments BV
Terheijdensweg 465
4825BK Breda
The Netherlands
Tel: +31(0)76 7505360 Fax: +31(0)76 7505370
E-mail: info@mtlbenelux.com

Cooper Crouse-Hinds Pte Ltd

No.2 Serangoon North Avenue 5
#06-01 Fu Yu Building
Singapore 554911
Tel: +65 6 487 7887 Fax: +65 6 487 7997
E-mail: sales@mtlsing.com.sg

MTL Instruments

Villa No. 4, Sector 2-17, Street 6
PO Box 53234,
Abu Dhabi, UAE
Tel: +971 2 446 6840 Fax: +971 2 446 6841
E-mail: mtlgulf@mtl-inst.com

Measurement Technology Limited

Great Marlings, Butterfield, Luton, Beds
England LU2 8DL
Tel: +44 (0)1582 723633 Fax: +44 (0)1582 422283
E-mail: enquiry@mtl-inst.com

MTL Incorporated

3413 N. Sam Houston Parkway W.
Suite 210
Houston TX 77086
USA
Tel: +1 281 571 8065 Fax: +1 281 571 8069
E-mail: csinfo@mtl-inst.com

