

9461-ET

Ethernet Gateway

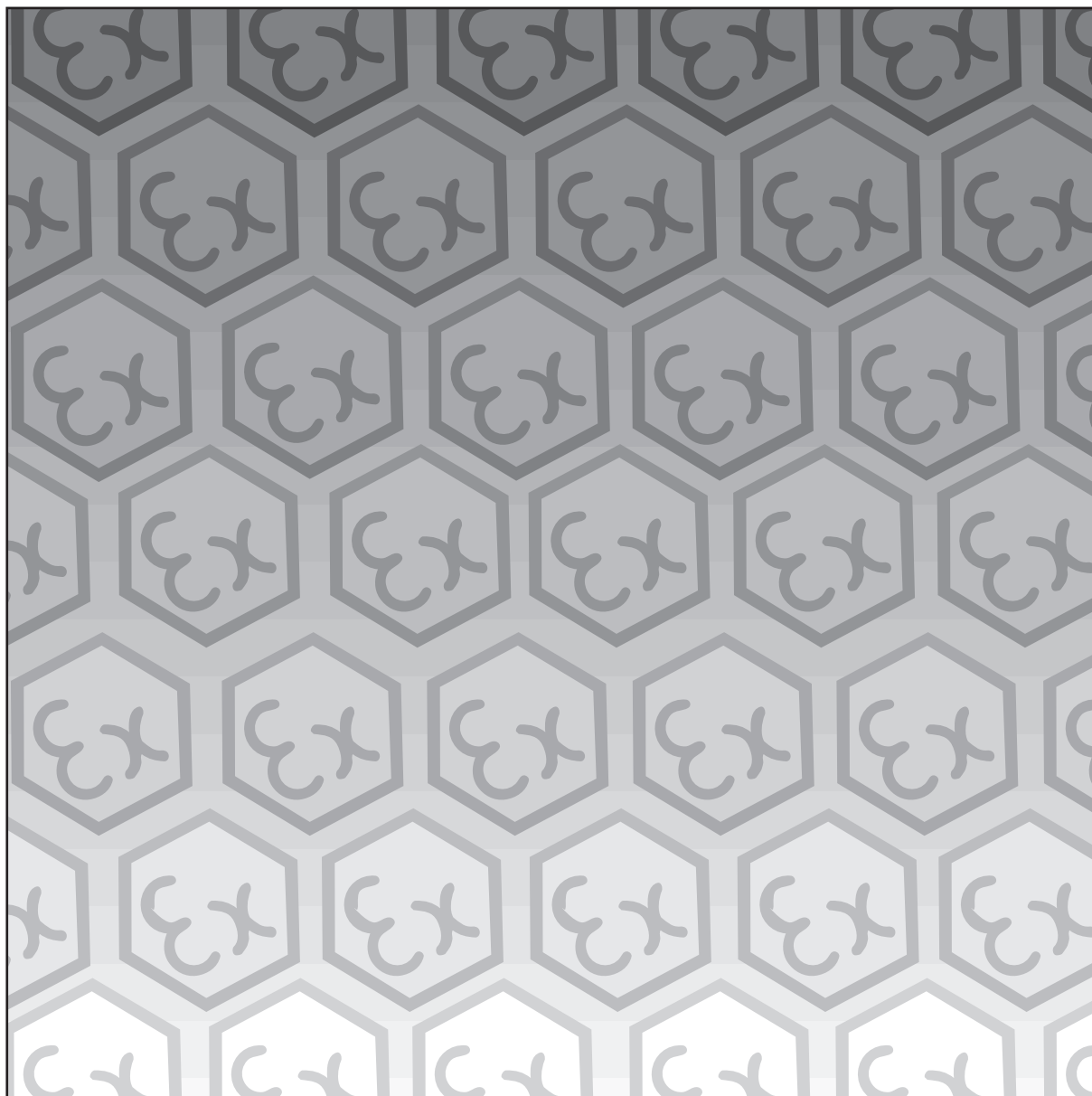

Instruction Manual

INM9461



CONTENTS

1	FEATURES	1
2	DESCRIPTION	2
3	INSTALLATION	2
3.1	Protection	2
3.2	Mechanical mounting	2
3.3	Electrical connections	3
4	SOFTWARE INTRODUCTION	5
4.1	Changing network settings	5
4.2	Setting the operating mode	6
5	REAL PORT MODE	8
5.1	Installing Real Port software	8
5.2	Confirming port registration	8
6	CONFIGURING REAL PORT	9
7	RS485 COMMUNICATIONS	10
8	RS422 COMMUNICATIONS	10
9	MODBUS GATEWAY MODE	11
10	ENVIRONMENTAL	12
11	WASTE REMOVAL INFORMATION	12
12	ACCESSORIES	12
13	APPROVALS	12
14	FM CERTIFICATION INFORMATION	13
15	ATEX & IECEx CERTIFICATION INFORMATION	13



1 FEATURES

- ◆ Intrinsically Safe ATEX / IECEx certified, FM / FMC approved
- ◆ Ga Ex ia IIC T4 GD (surface), Ma Ex ia I M1 (mining)
- ◆ Zone 1/ Division 1 mounting in a suitable enclosure
- ◆ Input voltage: 12V dc nominal (10 – 15.4V)
- ◆ Input current 150mA
- ◆ Extended temperature range (–20°C...+70°C)
- ◆ PoEx™ - "Power over Ethernet" powered device option - accepts module supply via the Cat5e cable*
- ◆ 10/100Mb Ethernet twisted pair (Cat5e) RJ45 Connection (100m max)
- ◆ High Performance ARM9 155MHz 32-bit RISC Processor (ARM926EJ-S)
- ◆ 2x Serial Communication Ports – Baud rates to 115K2 (RS232/TTL Compatible)
- ◆ 2x Serial Communication Ports – Baud rates to 115K2 (RS485/422 2 or 4 wire)
- ◆ Status LED's for :
 - ‘Power On’
 - Network ‘Link’ Established
 - Network ‘Tx/Rx Activity’
 - Serial Comms ‘Tx/Rx Activity’
- ◆ Simple configuration of IP Address etc.using 9461-ET Finder program
- ◆ Easy set-up of protocol conversion using Windows Internet Explorer or other similar browser. This selects protocols and mapping tables for Ethernet and Serial ports
- ◆ Gives ‘Ethernet Connectivity’ to Existing Equipment
- ◆ DIN Rail Mounting Module

**Note – PoEx is a simple adaptation of the IEEE 802.3af Power over Ethernet (PoE) standard to bring the benefits to the 9400 Range of Hazardous Area devices. This allows two spare pairs in the existing Cat5e cable to distribute the power supply from a 9466-ET Ethernet Switch (Power Sourcing Equipment – PSE) to each of the devices connected to its five ports (PD – Powered Device). This adaptation is necessary due to restrictions for Hazardous Area use. It is not implied that the device conforms to the 802.3af (PoE) standard.*

2 DESCRIPTION

The 9461-ET 10/100Mbps Ethernet Gateway allows existing equipment with a serial communication port to be connected to an Ethernet network.

Two protocols are available as standard:

- ◆ Real Port (Serial Gateway)
- ◆ Modbus/TCP \leftrightarrow Serial Modbus Gateway

Two 9-way D-type serial ports are provided which are RS232/TTL compatible. The module terminals T6 – T15 also provide two, 2- or 4-wire, RS485/RS422 ports giving a total of four serial ports.

The Gateway can also act as the host processor for the 9466 Managed Ethernet Switch giving remote access to the switch's management features over the Ethernet network.

3 INSTALLATION



WARNING: This equipment must be installed, operated and maintained only by trained competent personnel and in accordance with all appropriate international, national and local standard codes of practice and site regulation for intrinsically safe apparatus and in accordance with the instructions contained here. See also Sections 13, 14 & 15 for approvals and important conditions of safe use.

3.1 Protection

The module requires mounting within an enclosure providing a degree of protection of at least IP6x, in accordance with EN60529 and in a manner that does not impair the existing creepage and clearance distances. The enclosure must also comply with the requirements of Clauses 7 and 8 of EN50014 and be sealed to prevent the ingress of dust.

3.2 Mechanical mounting

3.2.1 DIN rail mounting

The module will 'snap-fit' onto standard DIN rail (TS35) to EN 50022. Height off rail - including any connectors but excluding cables = 112mm.

Tilt the module to engage the top DIN rail clips then rotate down and press to the DIN rail until the lower spring clip is properly engaged.

3.2.2 Flat panel mounting

The module has two fixing holes to enable it to be mounted with two M3.5 screws. Use the following dimension diagram to establish the hole positions. Depth - including connectors but excluding cables = 117mm.

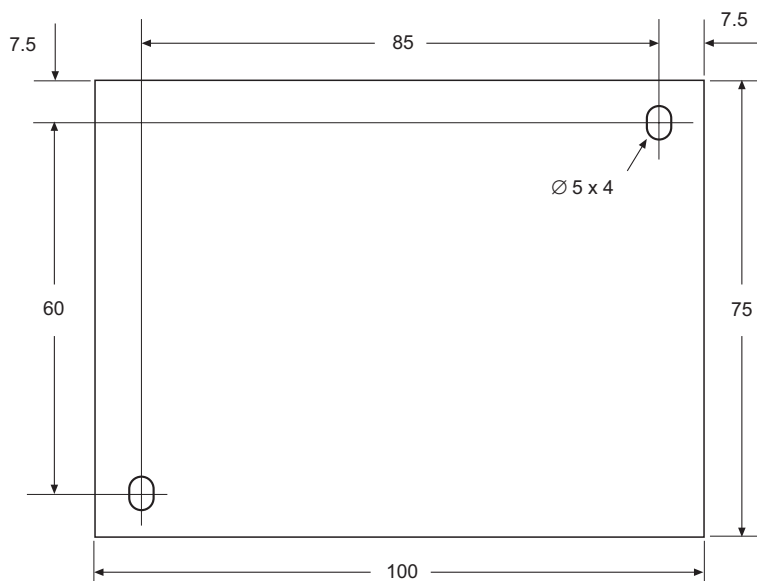

3.3 Electrical connections

DC power can be supplied to the equipment through the front panel screw terminals or alternatively using the Power over Ethernet (PoEx) option where DC power is supplied from a 9466-ET module down the Ethernet Cat5e (or Cat6) cable into the RJ45 connector on the front panel.



WARNING: Whichever wiring method of powering the modules is used, the supply to them must be derived from a suitably certified, intrinsically safe supply.

3.3.1 Screw Terminals

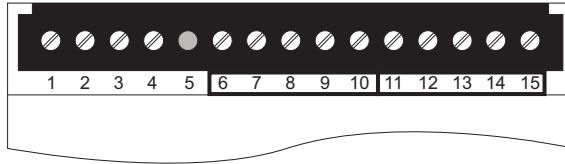

DC power input

Note: An alternative is to supply the power via the Cat5e cable to the RJ45 connector (PoEx)

Terminal No.	Function	
1	+12V dc in	When using PoEx – no supply is required on these terminals.
2	+12V dc in	
3	0V	
4	0V	

Note: 1. Terminals 1 & 2 and 3 & 4 are linked internally.

COM ports

Terminal No.	Function
6	Y – COM3 + TX/RX (2W) / +TX (4W)
7	Z – COM3 -TX/RX (2W) / -TX (4W)
8	A – COM3 +RX (4W)
9	B – COM3 -RX (4W)
10	Signal Ground 0V
11	Y – COM4 + TX/RX (2W) / +TX (4W)
12	Z – COM4 -TX/RX (2W) / -TX (4W)
13	A – COM4 +RX (4W)
14	B – COM4 -RX (4W)
15	Signal Ground 0V

3.3.2 Front Panel Connectors

RS232/TTL Ports

COM-1- Serial 9-way D-Type Male

Pin No.	Function
1	DCD
2	RXD
3	TXD
4	RS232/!TTL (Open Circuit = RS232 / 0V (pin5) = TTL)
5	Signal Ground 0V
6	N/C
7	RTS
8	N/C
9	+5V o/p

COM-2 Serial9-way D-Type Male

Pin No.	Function
1	DCD
2	RXD
3	TXD
4	RS232/!TTL (Open Circuit = RS232 / 0V (pin5) = TTL)
5	Signal Ground 0V
6	N/C
7	RTS
8	N/C
9	+5V o/p

Primary functions (may change with software variations)

COM1 = Gateway Serial Port – Software Protocol depends upon Gateway configuration

COM2 = Gateway Serial Port – Software protocol depends upon Gateway Configuration

COM3 = Gateway Serial Port – Software Protocol depends upon Gateway configuration

COM4 = Gateway Serial Port – Software Protocol depends upon Gateway configuration

The minimum cable pin connections required to connect to the serial port (COM 1 or 2) are shown below.

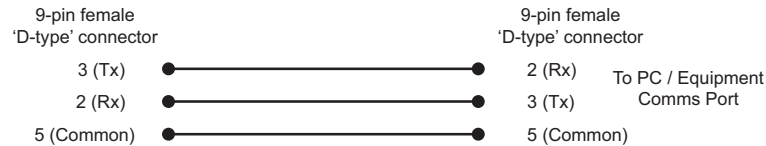

10/100 BASE-T Ethernet RJ45

Pin No.	Function	
1	TX +	When using PoEx – no supply is required on screw terminals 1 to 4 - see above.
2	TX –	
3	RX +	
4	Supply 12V - PoEx	
5	Supply 12V - PoEx	
6	RX –	
7	Supply 0V - PoEx	
8	Supply 0V - PoEx	

When connecting the Cat5e cable to a 9466 Ethernet switch, or other device that supports Auto MDI/MDI-X, a straight connected RJ45 cable is used, a cross-over cable is only required if the other device does not support this auto detect mode.

It is recommended that Cat5e cables for Hazardous Area Zone 1 use are 'Blue' in colour and are of good quality (see accessories section), the Safe Area cables being a colour other than blue to aid identification.

4 SOFTWARE INTRODUCTION

9461-ET may be operated in one of two modes:

- ◆ Real Port
- ◆ Modbus Gateway

Real Port is the factory default mode but either mode may be selected with the Gateway management software installed in the gateway and accessible with an internet browser, such as Internet Explorer. To access the software, connect the LAN port to a PC, open a browser and type in the Gateway IP address. The default (Factory Set) IP Address is 192.168.0.200. To discover or to change the IP address to suit your network, use the following procedure, otherwise continue to section 4.2.

4.1 Changing network settings

Run the program 9461-ET Finder.exe. This will automatically search for and locate any 9461-ET gateways connected to the network.

Select (click on) the device you want to configure, then click the configure IP Settings button, which will bring up the following screen.

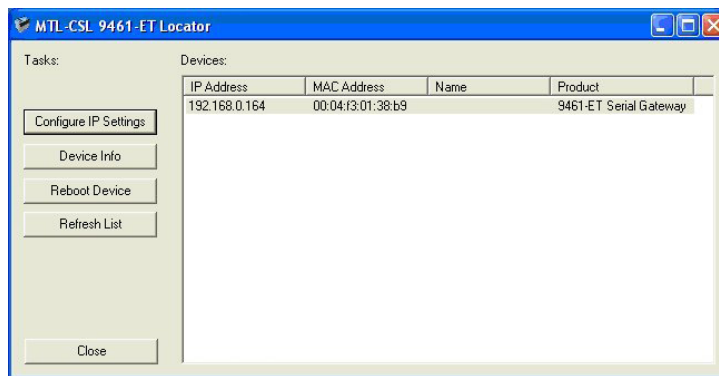

Type in the manual settings you require and then enter the password "CSL". Click the Apply button to send the settings to the 9461-ET. Next reboot the device either by powering it down or by clicking the Reboot Device button (see "Locator" screen above).

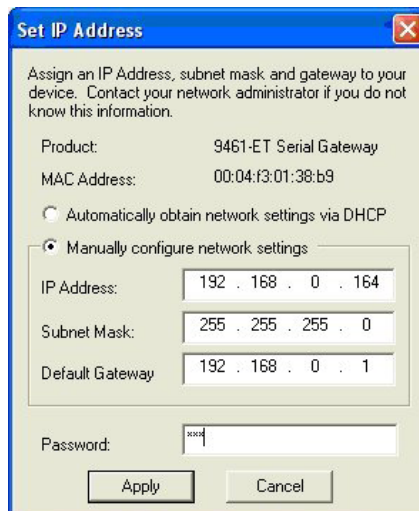

4.2 Setting the operating mode

On entering the Gateway IP address in the browser, the setup software screen should appear, as follows.

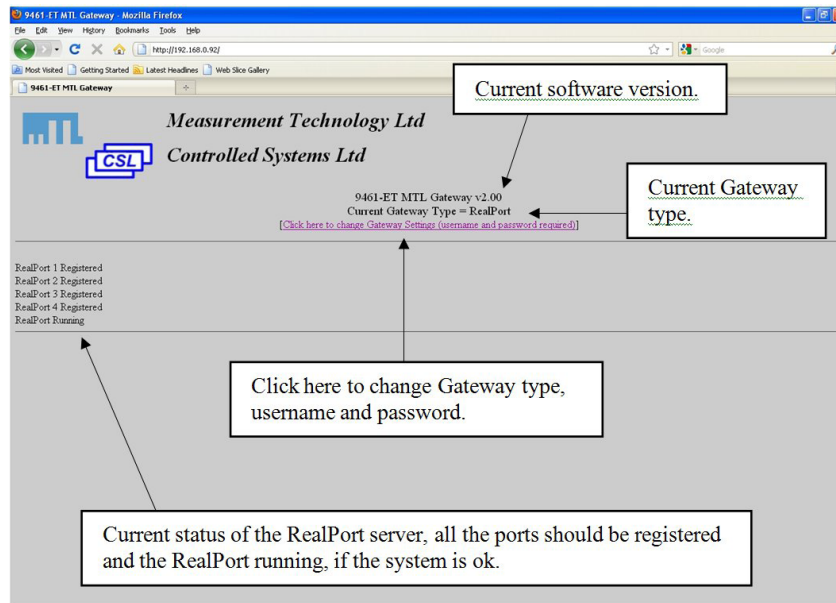

When you click on 'change Gateway Settings' link a dialog comes up asking for user name and password. The defaults are 'USERNAME' and 'PASSWORD', but these can be changed later.

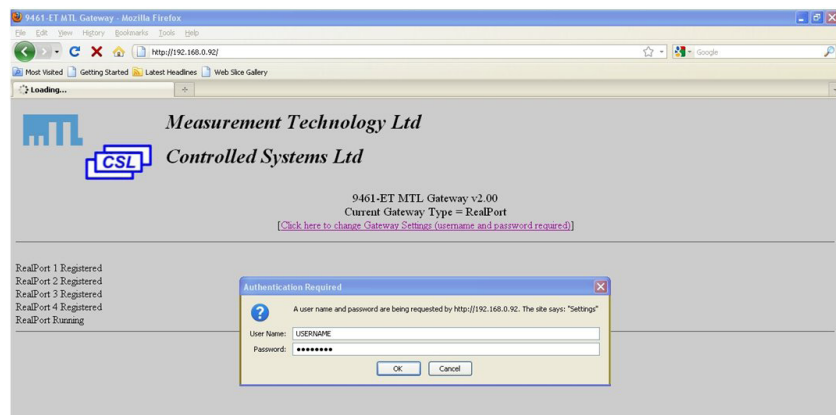

When a correct username and password are entered the following appears allowing the system settings to be altered.

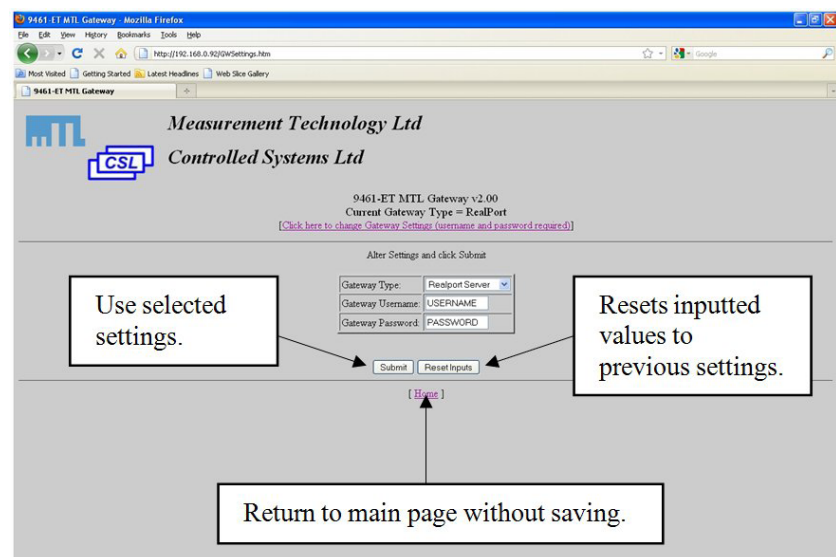

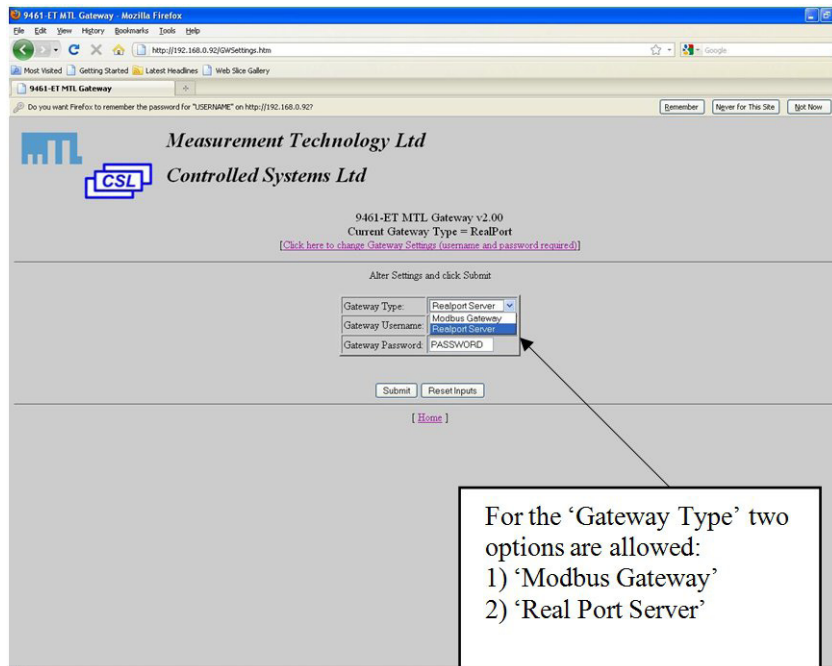

If you do not change any of the settings and click submit the system will not change.

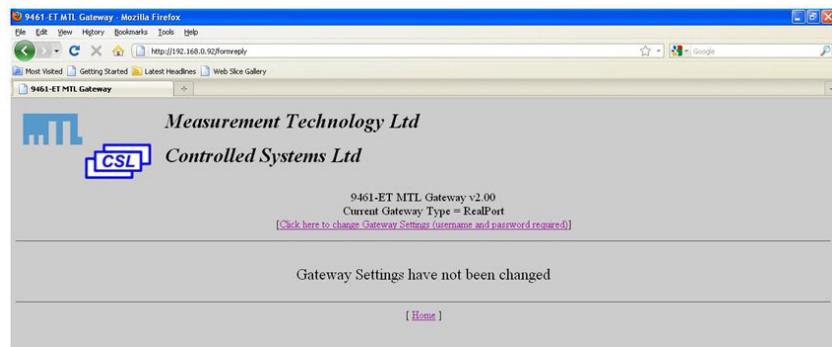

When the settings have changed this time out screen appears whilst the unit reboots. When the timer elapses a link will appear to return to the main page.

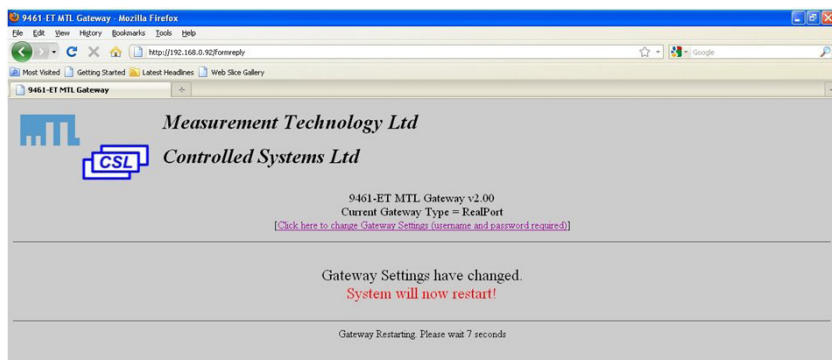

5 REAL PORT MODE

The 9461-ET Serial Gateway utilises the Digi RealPort software, which creates a virtual communications port on the device. If the Real Port software is already installed, go to section 5.2.

5.1 Installing Real Port software

To operate in Real Port mode, download the Real Port software from the “Industrial Networks” section of www.mtl-inst.com and follow the setup instructions.

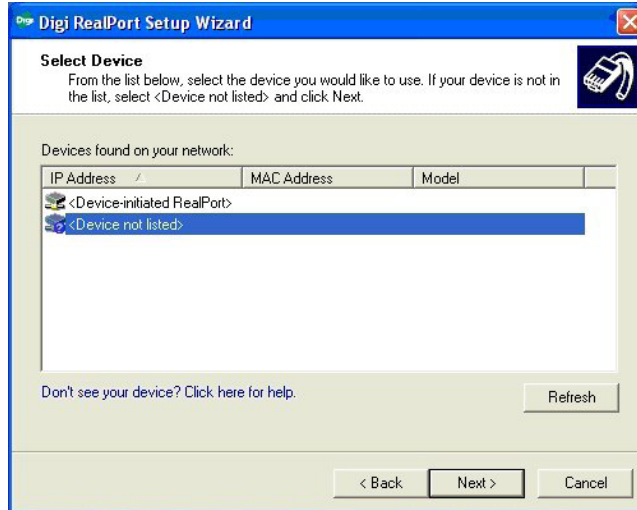

After starting the Real Port Software the following screen will appear.

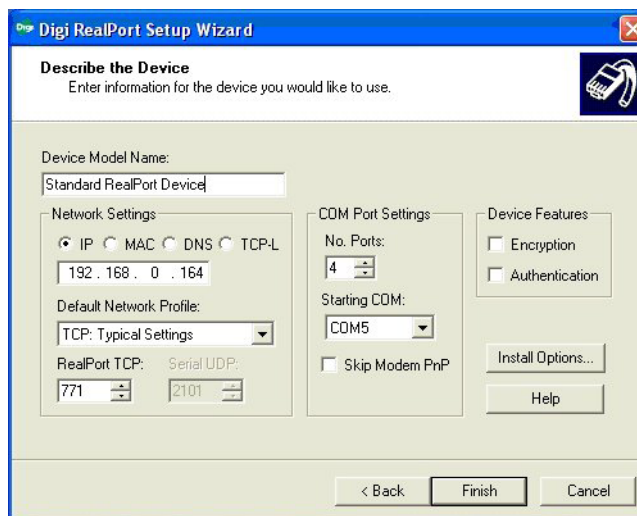

Select “Device not listed” and then click the Next button.

Enter the settings shown, ensuring that the IP address is the one you have decided to use for the device. Click the Finish button to complete the installation.

5.2 Confirming port registration

The device offers 4 ports for use by Real Port. These ports are as follows:-

Port 1 RS232	Real Port 1
Port 2 RS232	Real Port 2
Port 3 RS485/422	Real Port 3
Port 4 RS485/422	Real Port 4

The PC browser can be used to confirm that the ports are registered and that Real Port is running, as shown in the following screen shot.

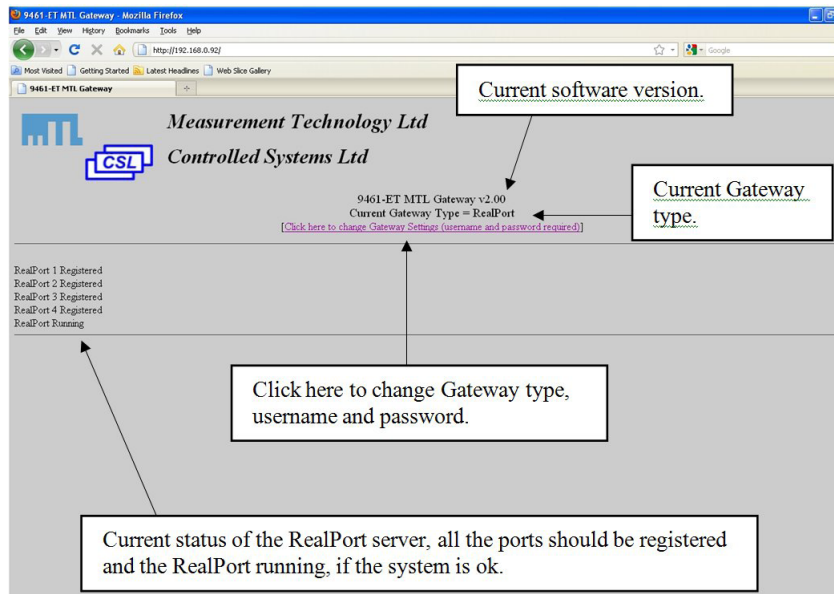

Note: This is the only webpage accessible in the Real Port mode.

6 CONFIGURING REAL PORT

After installation, ports 3 and 4 need to be configured as follows.

Go to the Device Manager (Start|Control Panel|System|Device Manager). Find the check box via the following route:-

In the Device Manager window, click on *Multi-port serial adapters* to view *Standard RealPort Device*. Double-click *Standard RealPort Device* to open the tabbed dialog box.

Choose the *Advanced* tab and click on the *Properties* button.

Choose *Port 3* in the device list and then open the *Advanced* tab.

Click the *Custom Settings* button and Check - **Always use RTS Toggle for Flow Control**.

NOTE: Do this, even if you are not using Hardware handshaking, as this setting is required for correct RS485/RS422 operation.

This procedure for Port 3 is shown below. Repeat for Port 4.

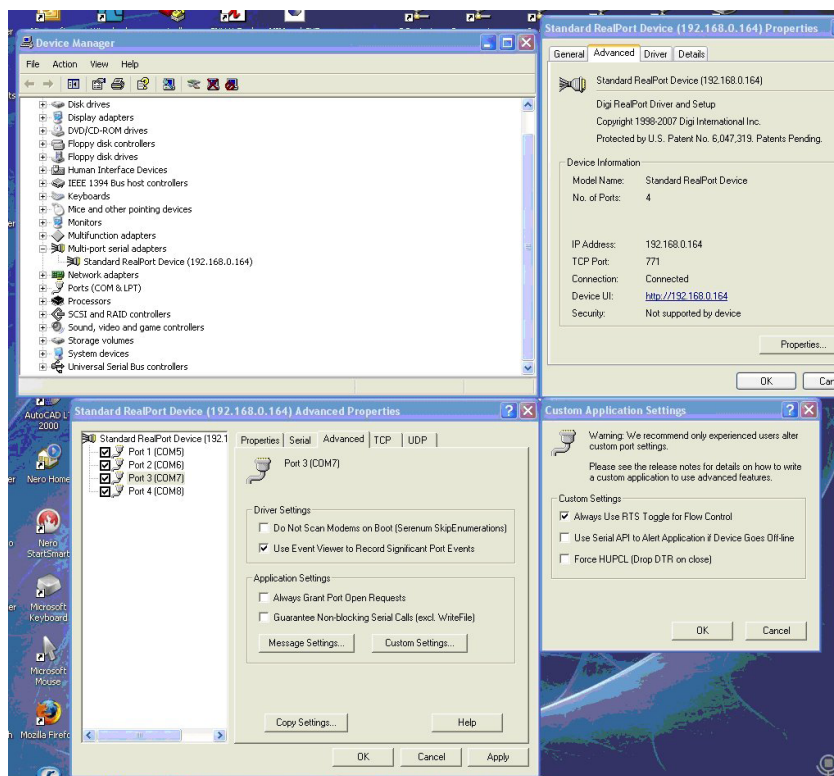

7 RS485 COMMUNICATIONS

In order to use the port for RS485 communications, the TCP tab for Port 3 and Port 4 must be set to "Ignore line and serial settings". Click the "Ignore Settings" button for each port and ensure the settings are the same as those shown below. You may need to reboot after changing these settings.

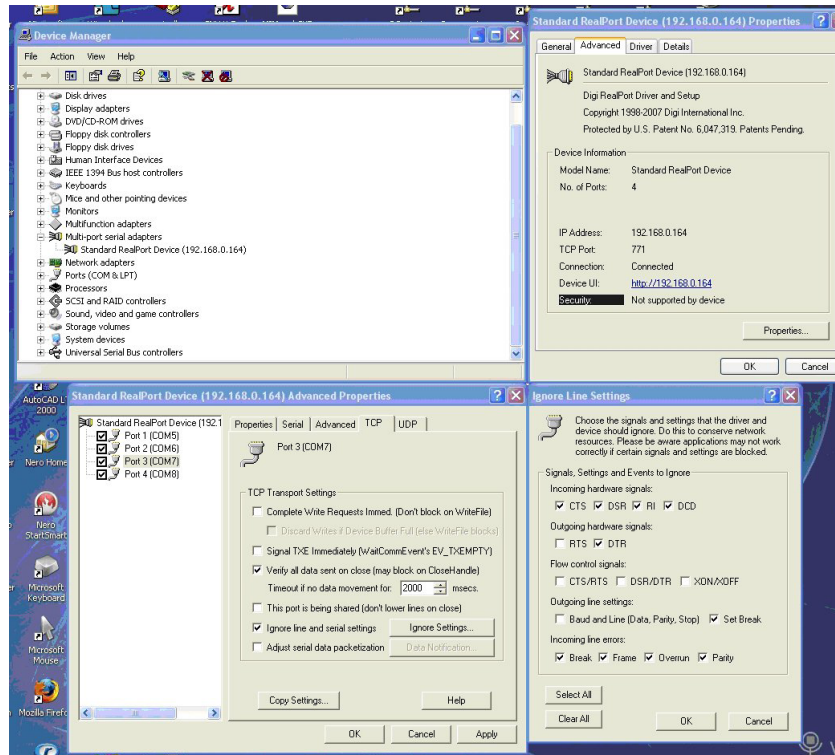

8 RS422 COMMUNICATIONS

In order to use the port for RS422 communications, the TCP tab for Port 3 and Port 4 must be set to "Ignore line and serial settings". Click the "Ignore Settings" button for each port and ensure the settings are the same as those shown below. You may need to reboot after changing these settings.

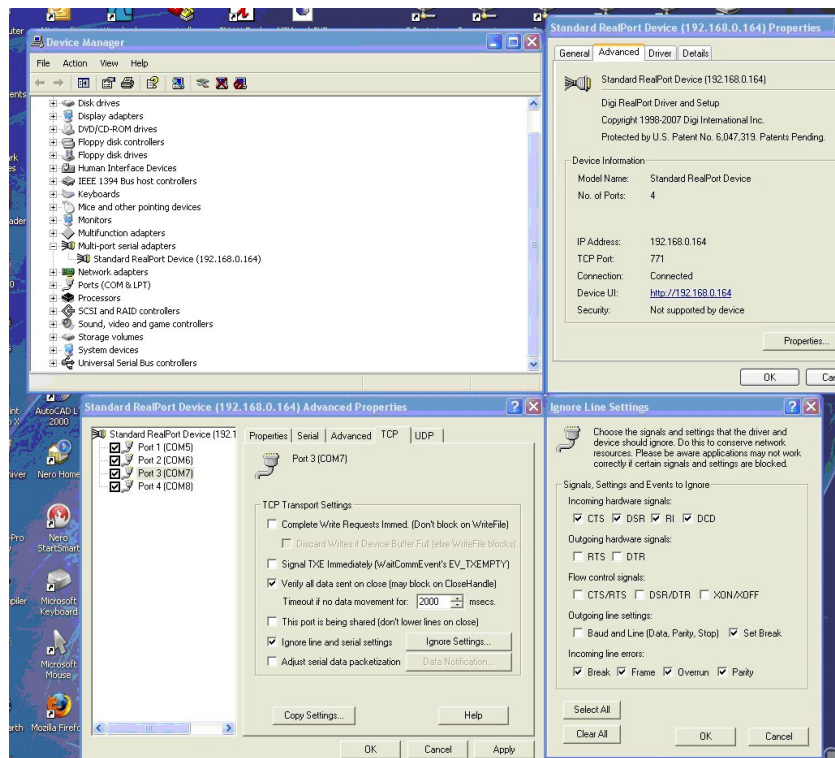

9 MODBUS GATEWAY MODE

When set for Modbus Gateway the following Configuration/Diagnostic screens are accessible via the web browser.

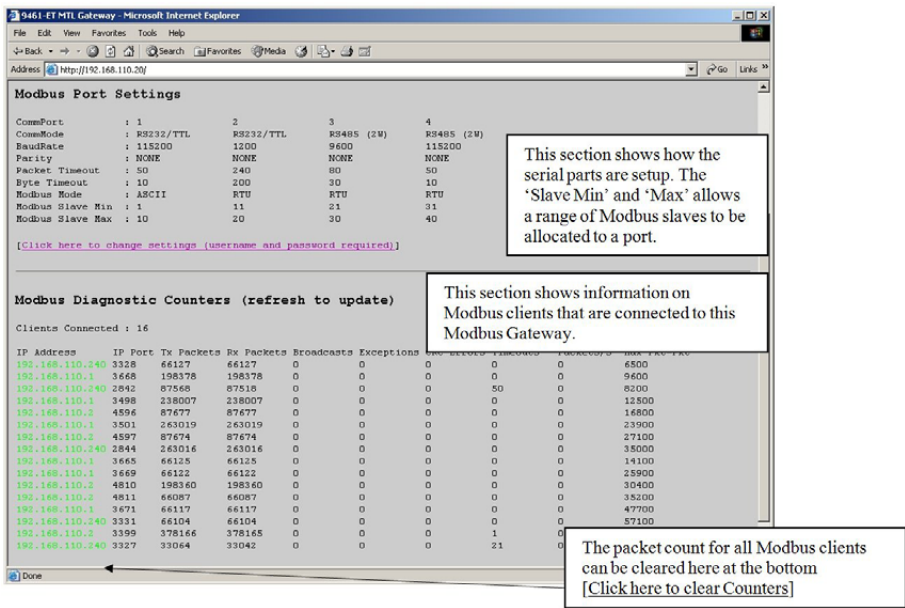

Click on the link in the upper part of this screen to modify the port settings. Possible settings for the list boxes are shown below.

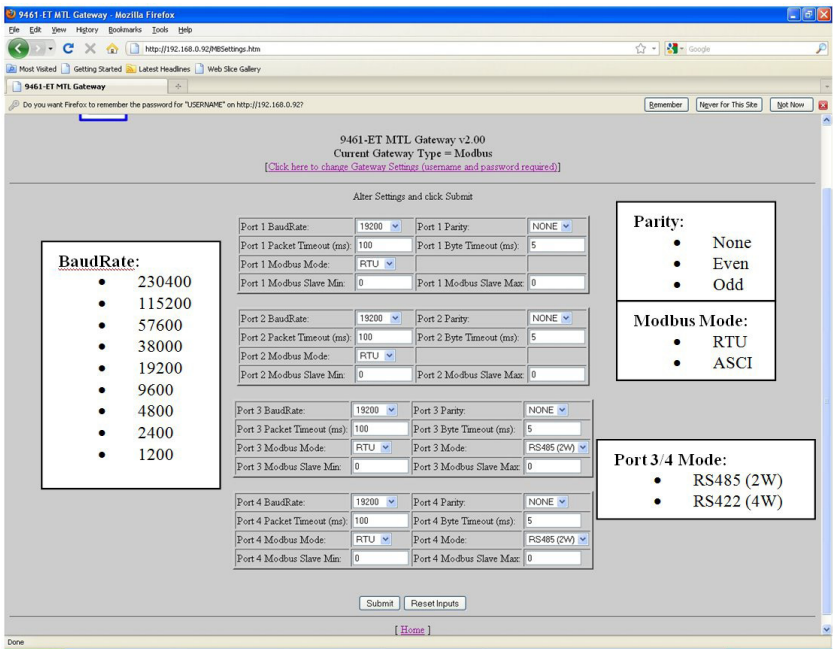

On completion of the settings, click on the *Submit* button to view the final page.

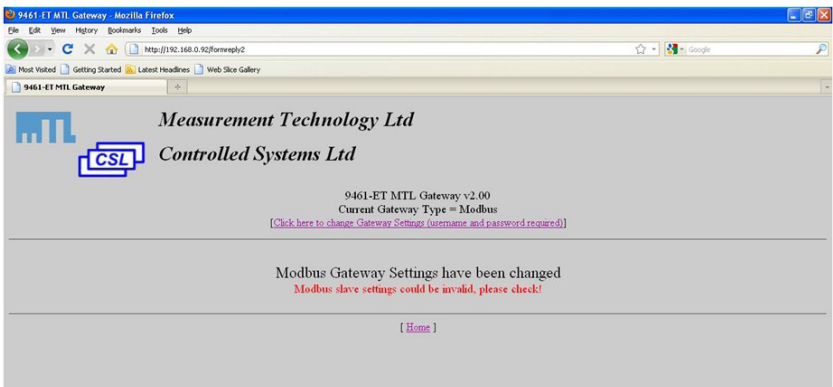

Modbus TCP packets will be forwarded out of the configured serial ports to the Modbus slaves, and their replies returned to the Modbus TCP Master.

There can be up to a maximum of 16 connected Modbus/TCP clients, each can communicate to multiple slaves/ports as configured.

10 ENVIRONMENTAL

Operating Temperature	-20°C...+70°C
Storage Temperature	-20°C...+70°C
Humidity	5...95% RH, non condensing

11 WASTE REMOVAL INFORMATION



The electronic equipment within must not be treated as general waste. By ensuring that this product is disposed of correctly you will be helping to prevent potentially negative consequences for the environment and human health, which could otherwise be caused by incorrect waste handling of this product.

For more detailed information about the take-back and recycling contact **MTL**.

12 ACCESSORIES

For interconnecting the 9460-ET range of products, we offer approved RJ45 Cat5e UTP cables in various standard lengths (0.5...100m)

Ordering details

Copper Twisted Pair UTP Patch Cable (Blue) pre-terminated RJ45-RJ45 connectors

Part No. CSL9405-xx (where -xx is used to signify the length of the cable)

13 APPROVALS

The operating parameters must not exceed those as detailed on the certificate.

- ◆ 2004/108/EC EMC Directive
- ◆ 2006/95/EC Low Voltage Directive

Region	Europe (ATEX)	International IECEx	USA	Canada
Authority	SIRA	SIRA	FM	FMC
Standard	EN 60079-0:2006, EN 60079-11:2007, IEC 60079-26:2006, EN 60079-28:2007, EN 50303:2000, IEC 61241-0:2004, IEC 61241-11:2005	IEC 60079-0:2004, IEC 60079-11:2006, IEC 60079-28:2006-08, IEC 61241-0:2004, IEC 61241-1:2005	3600 3610 3810	C22.2 No. 61010.1:2004 C22.2 No. 157:1992 CAN/CSA-E60079-0:2007 CAN/CSA-E60079-11:2002
Approved for	⊕ II 1GD Ga Ex ia IIC T4 Ex iaD 20 T135°C (Ta = -40°C to +70°C)* ⊕ I M1 Ma Ex ia I (Ta = -40°C to +70°C)	Ga Ex ia IIC T4 Ex iaD 20 T135°C Ma Ex ia I (Ta = -40°C to +70°C)*	IS/1/1/ABCD/T4 Ta=70°C I/O/AEx ia IIC T4 Ta=70°C	IS/1/1/ABCD/T4 Ta=70°C I/O/AEx ia IIC T4 Ta=70°C
Cert. no.	Sira 07ATEX2064X	IECEx SIR 07.0042X	3034995	3034995C

* see specification for operating temperature range

14 FM CERTIFICATION INFORMATION

Special Condition of Use - Factory Mutual (USA & Canada)

1. The Model 9461-ET shall be installed in compliance with the enclosure, mounting, spacing and segregation requirements of the ultimate application.
2. The Model 9461-ET shall be excluded from use in environments containing chemical vapours of the Ketone or Ester families.

15 ATEX & IECEx CERTIFICATION INFORMATION

The following information is in accordance with the Essential Health and Safety Requirements (Annex II) of the EU Directive 94/9/EC [the ATEX Directive - safety of apparatus] and is provided for those locations where the ATEX Directive is applicable.

General

- a) This equipment must only be installed, operated and maintained by competent personnel. Such personnel shall have undergone training, which included instruction on the various types of protection and installation practices, the relevant rules and regulations, and on the general principles of area classification. Appropriate refresher training shall be given on a regular basis. [See clause 4.2 of EN 60079-17].
- b) This equipment has been designed to provide protection against all the relevant additional hazards referred to in Annex II of the directive, such as those in clause 1.2.7.
- c) This equipment has been designed to meet the requirements of intrinsically safe electrical apparatus in accordance with EN 60079-0, EN 60079-11 and EN 60079-26.

Installation

- a) reference to the IEC code of practice IEC 60079-14. In addition, particular industries or end users may have specific requirements relating to the safety of their installations and these requirements should also be met. For the majority of installations the Directive 1999/92/EC [the ATEX Directive - safety of installations] is also applicable.
- b) Unless already protected by design, this equipment must be protected by a suitable enclosure against:
 - i) mechanical and thermal stresses in excess of those noted in the certification documentation and the product specification.
 - ii) aggressive substances, excessive dust, moisture and other contaminants.
- c) This equipment is intrinsically safe electrical apparatus and is normally mounted in a hazardous area. When mounted in a Zone 1 location the apparatus must be provided with an enclosure, which offers an additional degree of protection appropriate to the area classification.

Read also the Special Conditions for Safe Use for any additional or more specific information.

Special Conditions for Safe Use

1. When used with Group I gases, the Modules shall each be mounted within an enclosure providing a degree of protection of at least IP54, in accordance with EN 60529, and in a manner that does not impair the existing creepage and clearance distances. The enclosure shall also comply with the requirements of Clauses 7 and 8 of EN 60079-0:2006.
2. The connectors do not meet the ingress protection rating of IP20, therefore, this shall be taken into consideration during the installation of the 9400 Series Ethernet Modules when used with Group II gases, and each module shall be provided with an enclosure that is commensurate with the environment into which it is installed.
3. The supply to the modules must be derived from a suitably certified, intrinsically safe supply.

Inspection and maintenance

- a) Inspection and maintenance should be carried out in accordance with European, national and local regulations which may refer to the IEC standard IEC 60079-17. In addition specific industries or end users may have specific requirements which should also be met.
- b) Access to the internal circuitry must not be made during operation.

Repair

This product cannot be repaired by the user and must be replaced with an equivalent certified product.

Marking

Each device is marked in accordance with the Directive and CE marked with the Notified Body Identification Number.

This information applies to products manufactured during or after the year 2011.

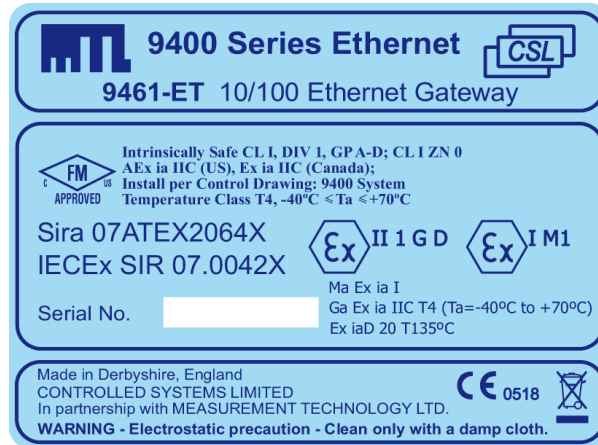

**Replace this page with the first page of
the PDF of the Control Drawing**

**Replace this page with the second page of
the PDF of the Control Drawing**

This page left intentionally blank

This page left intentionally blank

This page left intentionally blank

MTL Instruments Pty Limited

9 /12 Billabong Street
Stafford
Queensland 4053
Australia
Tel: + 61 1300 308 374 Fax: + 61 1300 308 463
E-mail: enquiries@mtlaus.com.au

Cooper Electric (Shanghai) Co. Ltd.

Room 2001, China Life Tower
16 Chao Yang Men Wai Street
Chao Yang District, Beijing
China 100020
Tel: + 86 10 5980 0288 Fax: + 86 10 8562 5725
E-mail: bjsales@mtl-inst.cn

MTL Instruments sarl

Les Carrés du Parc
10 rue des Rosiéristes
69410 Champagne au Mont d'Or
France
Tel: +33 (0)4 78 64 98 32 Fax: +33 (0)4 78 35 79 41
E-mail: info@mtl-inst.fr

MTL Instruments GmbH

An der Gumpgesbrücke 17
D-41564 Kaarst
Germany
Tel: +49 (0)2131 718930 Fax: +49 (0)2131 7189333
E-mail: info@mtl.de

MTL India

No. 36, Nehru Street
Off Old Mahabalipuram Road
Sholinganallur
Chennai - 600 119
India
Tel: + 91 (0)44 24501660/24501857 Fax: + 91 (0)44 24501463
E-mail: sales@mtlindia.com

MTL Italia srl

Via Cantù 11
I - 20092 Cinisello Balsamo MI
Italy
Tel: +39 (0)2 61802011 Fax: +39 (0)2 61294560
E-mail: info@mtl-inst.it

Cooper Crouse-Hinds Japan KK

MT Building 3F
2-7-5 Shiba Daimon
Minato-ku Tokyo
Japan 105-0012
Tel: +81 (0)3 6430 3128 Fax: +81 (0)3 6430 3129
E-mail: info@cooperindustries.jp

Cooper Crouse-Hinds Korea

12F, Vision Tower
707-2 Yeoksam-dong, Gangnam-gu
Seoul 135-080
South Korea
Tel: +82 2 3484 6795 Fax: +82 2 3484 6778
E-mail: MTLKorea-enquiry@cooperindustries.com

MTL Instruments BV

MTL Instruments BV
Terheijdensweg 465
4825BK Breda
The Netherlands
Tel: +31(0)76 7505360 Fax: +31(0)76 7505370
E-mail: mtl.benelux@cooperindustries.com

Cooper Crouse-Hinds Pte Ltd.

No.2 Serangoon North Avenue 5
#06-01 Fu Yu Building
Singapore 554911
Tel: +65 6 487 7887 Fax: +65 6 487 7997
E-mail: sales.mtlsing@cooperindustries.com

MTL Instruments

Villa No. 4, Sector 2-17, Street 6
PO Box 53234,
Abu Dhabi, UAE
Tel: +971 2 446 6840 Fax: +971 2 446 6841
E-mail: mtlgulf@mtl-inst.com

Measurement Technology Limited

Great Marlings, Butterfield, Luton, Beds
England LU2 8DL
Tel: +44 (0)1582 723633 Fax: +44 (0)1582 422283
E-mail: enquiry@mtl-inst.com

Cooper Crouse-Hinds MTL Inc

3413 N. Sam Houston Parkway W.
Suite 210
Houston TX 77086
USA
Tel: +1 281 571 8065 Fax: +1 281 571 8069
E-mail: csinfo@mtl-inst.com

